

RIBAG



KIVO

/
essence of light

KIVO

RIBAG Design Studio

KIVO setzt jeden Raum brillant in Szene. Die exzellente Lichtqualität und die optimale Lichtverteilung sorgen für einen hohen Sehkomfort. Mit ihrer charaktervollen Optik erscheint KIVO als elegante, stimmungsvolle Leuchte im Wohn- und Objektbereich. Durch die individuellen Gestaltungsmöglichkeiten mit verschiedenen Blenden, passt sie sich dem Interior Design auf zeitlose Art und Weise an und strahlt eine persönliche Note aus.

KIVO brilliantly sets the scene in any room. The excellent quality of light and the optimal light distribution ensure a high level of visual comfort. Thanks to the individual design options with different shades, it adapts to the interior design in a timeless way and radiates a personal touch.

ribag.com/kivo







KIVO Pendelleuchten Ø 140 mm mit Wechselblende Schwarznuss, Sonderanfertigung mit 4er Tragschiene (auf Anfrage)
KIVO pendant lamps Ø 140 mm with interchangeable shades black walnut, customized with 4-gang mounting rail (on request)

- ◀ **KIVO Pendelleuchten Ø 140 mm mit Wechselblenden schwarz**
KIVO pendant lamps Ø 140 mm with interchangeable shades black



KIVO Pendelleuchten Ø 140 mm
mit Wechselblenden Eiche
KIVO pendant lamps Ø 140 mm
with interchangeable shades oak



**KIVO Decken- und Pendelleuchten Ø 140 mm
mit Wechselblenden schwarz**
KIVO mounted and pendant lamps Ø 140 mm
with interchangeable shades black



KIVO Deckenleuchten Ø 270 mm
mit Wechselblenden Eiche
KIVO mounted lamps Ø 270 mm
with interchangeable shades oak



KIVO Pendelleuchten Ø 270 mm
mit Wechselblenden schwarz
KIVO pendant lamps Ø 270 mm
with interchangeable shades black





Einfach austauschbare Blenden
mit Magnethaftung.
Easily replaceable shades with
magnetic adhesion.

KIVO Pendelleuchte Ø 270 mm
mit verschiedenen Wechselblenden
KIVO pendant lamp Ø 270 mm
with intervarious interchangeable shade

Planungshinweise:
 Sämtliches Zubehör separat bestellen
Planning guide:
 Order all accessories separately

KIVO 140

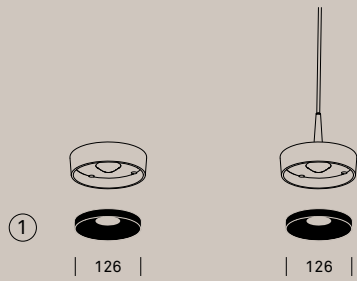

Montagevarianten
 Mounting options

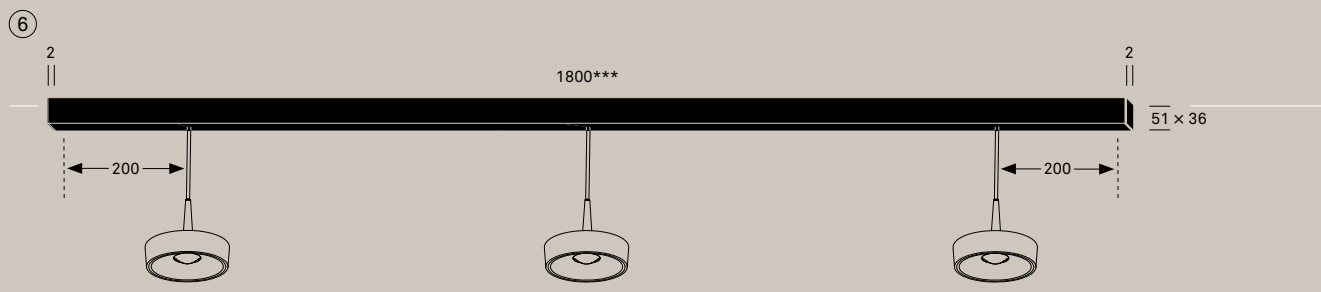
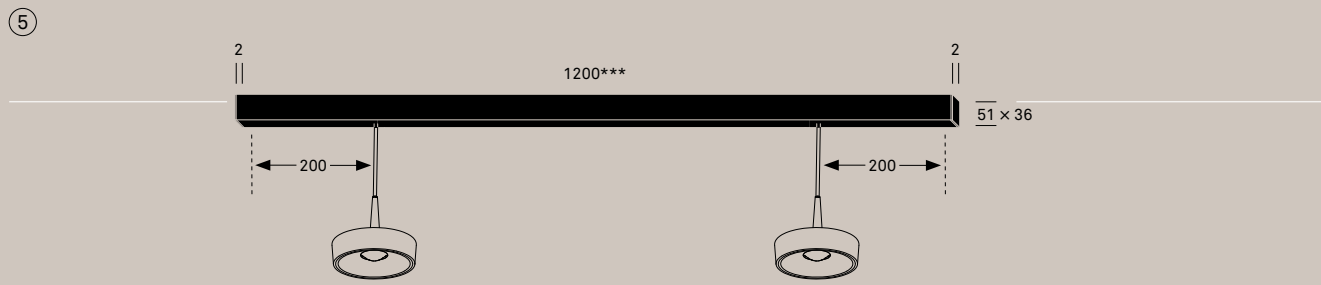
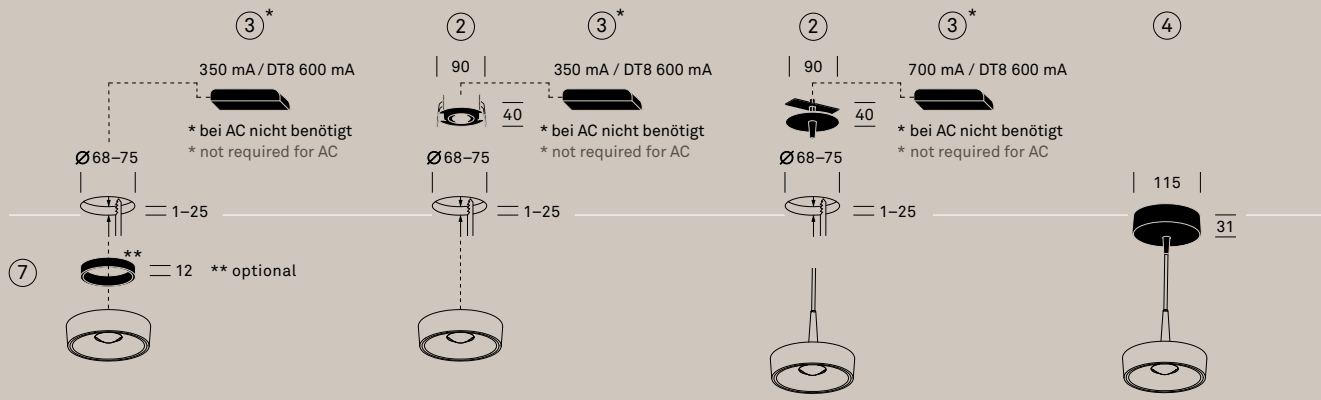

KIVO 270

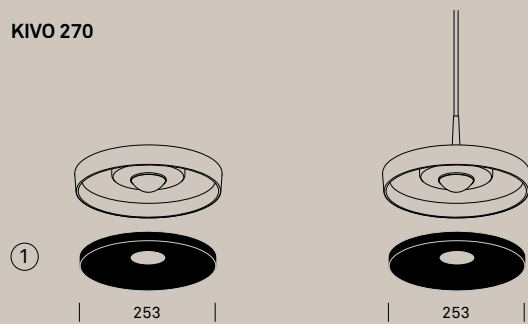

Montagevarianten Mounting options

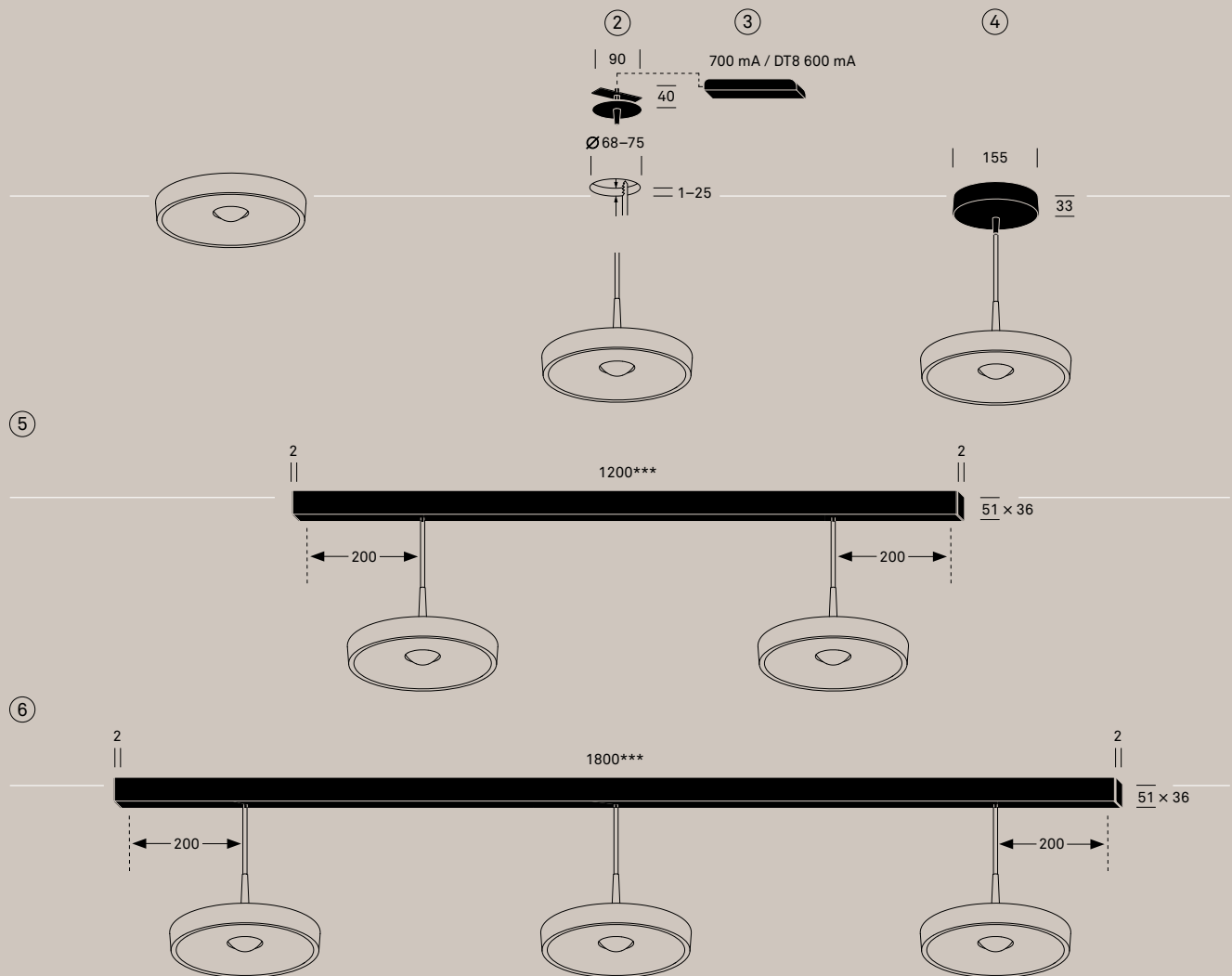

- 1 Wechselblende
Interchangeable shade
- 2 Hohlraumadapter
Cavity adapter
- 3 Betriebsgerät
Control gear

- 4 Baldachin mit Betriebsgerät
Canopy with control gear
- 5 Tragschiene 2 Pendelleuchten
(kompatibel mit MILUM-
Lichtsystem)
Mounting rail for 2 pendant lamps
(compatible with MILUM lighting
system)

- 6 Tragschiene 3 Pendelleuchten
(kompatibel mit MILUM-
Lichtsystem)
Mounting rail for 3 pendant lamps
(compatible with MILUM lighting
system)
- 7 Distanzring (optional)
Distance ring (optional)

*** Länge ohne Endplatten
Length without end plates



43

| Ø140 |

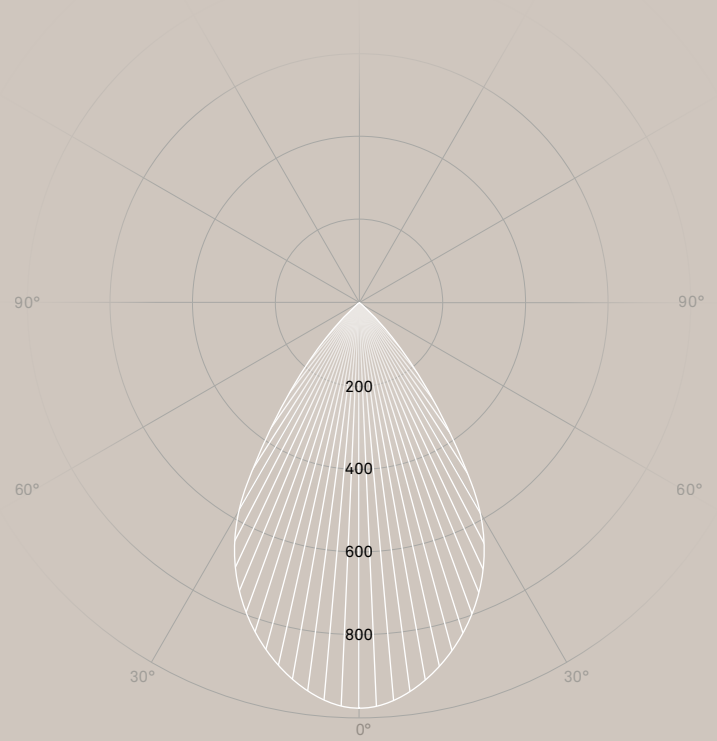

C90 / C270



cd / 1000 lm

C0 / C180



Deckenleuchten Ceiling lamps

Ø 140 mm
mit externem Betriebsgerät
with external control gear

Leuchtengehäuse Lamp housing	Alu-Druckguss Diecast aluminium
Farben Colours	schwarz RAL 9005 / grau RAL 9006 / weiss RAL 9003, Wechselblenden in verschiedenen Farben, separat bestellen black RAL 9005 / grey RAL 9006 / white RAL 9003, Interchangeable shades in different colours, order separately
Farbtemperaturen Colour temperatures	2700 / 3000 / 4000 / 2200–5000 K
Leuchtenlichtstrom Luminaire luminous flux	630–1350 lm
Anschlussleistung Connected load	11–12 W
Nutzlebensdauer LED Service life LED	50'000 h L90 B10 (Ta 25 °C)
Betriebsgerät Control gear	EVG 230 V / 50 Hz, Konstantstrom 350 mA / DT8 600 mA (Betriebsgerät separat bestellen) PS 230 V / 50 Hz, constant current 350 mA / DT8 600 mA (order control gear separately)
Lichtregelung Lighting control	Ein / Aus, PhasenDIM, DALI / TouchDIM, DALI DT8 On / Off, phase-cut, DALI / TouchDIM, DALI DT8

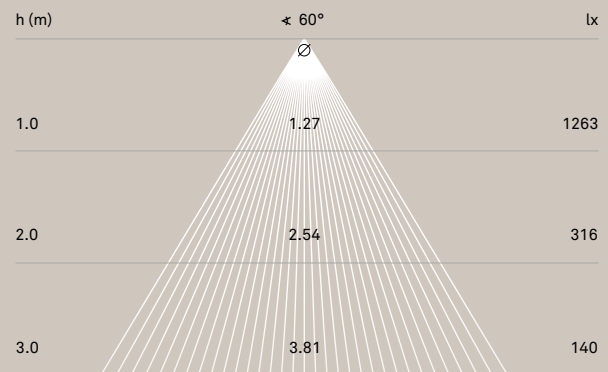

Zur Montage an Decke
(Pflichtzubehör separat
bestellen)

For mounting on the ceiling
(order essential accessories
separately)

Hochwertige Glaslinsen-Technologie mit Ausstrahlwinkel 60°
High-quality glass lens technology with a beam angle of 60°

Pflichtzubehör:
Wechselblenden, externe
Betriebsgeräte

Essential accessories:
Interchangeable shades,
external control gears

Optionales Zubehör:
Hohlraumadapter, Distanzring
Optional accessories:
Cavity adapter, distance ring

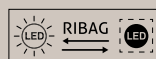



43

| Ø140 |

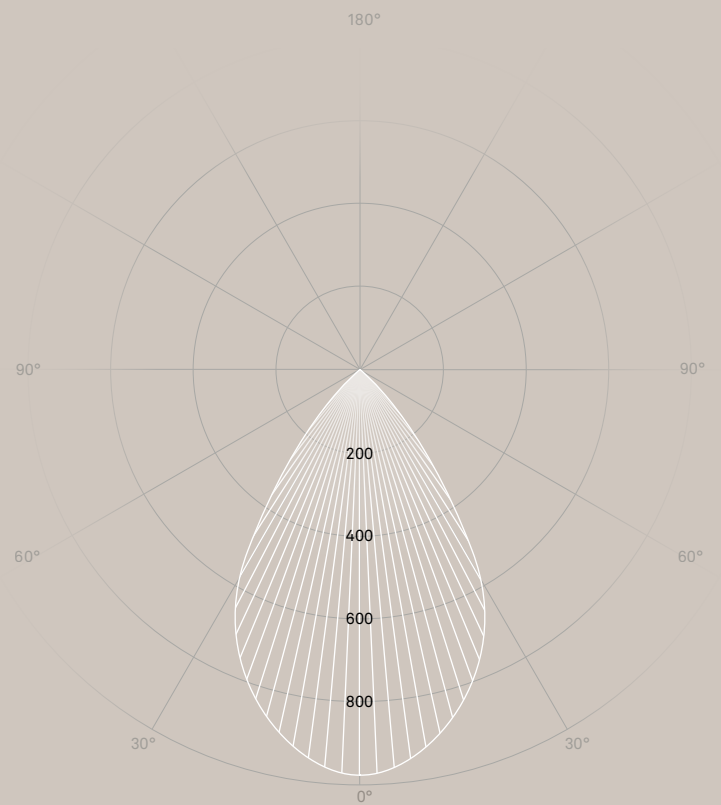

C90 / C270

C0 / C180

cd / 1000 lm



Deckenleuchten Ceiling lamps

Ø 140 mm AC (230 V)

Leuchtengehäuse
Lamp housing

Alu-Druckguss
Diecast aluminium

Farben
Colours

schwarz RAL 9005 / grau RAL 9006 / weiss RAL 9003,
Wechselblenden in verschiedenen Farben, separat bestellen
black RAL 9005 / grey RAL 9006 / white RAL 9003,
Interchangeable shades in different colours, order separately

Farbtemperaturen
Colour temperatures

2700 / 3000 / 4000 K (auf Anfrage)
2700 / 3000 / 4000 K (on request)

Leuchtenlichtstrom
Luminaire luminous flux

920 lm

Anschlussleistung
Connected load

12 W

Nutzlebensdauer LED
Service life LED

50'000 h L90 B10 (Ta 25 °C)

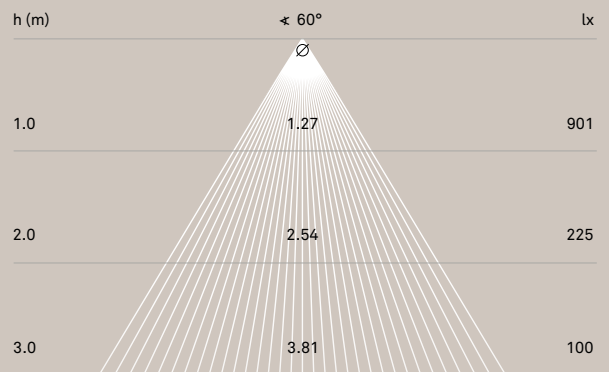

Zur Montage an Decke und Anschluss an 230 V AC / 50 Hz Netzspannung, dimmbar via LED-Phasendimmer
(Liste kompatibler Dimmer: ribag.com/downloads)

For mounting on the ceiling and connection to 230 V AC / 50 Hz mains voltage, dimmable with LED-phase-cut dimmer (List of compatible dimmers: ribag.com/downloads)

Hochwertige Glaslinsen-Technologie mit Ausstrahlwinkel 60°
High-quality glass lens technology with a beam angle of 60°

Pflichtzubehör:
Wechselblenden
Essential accessories:
Interchangeable shades

Optionales Zubehör:
Hohlraumadapter, Distanzring
Optional accessories:
Cavity adapter, distance ring

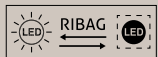

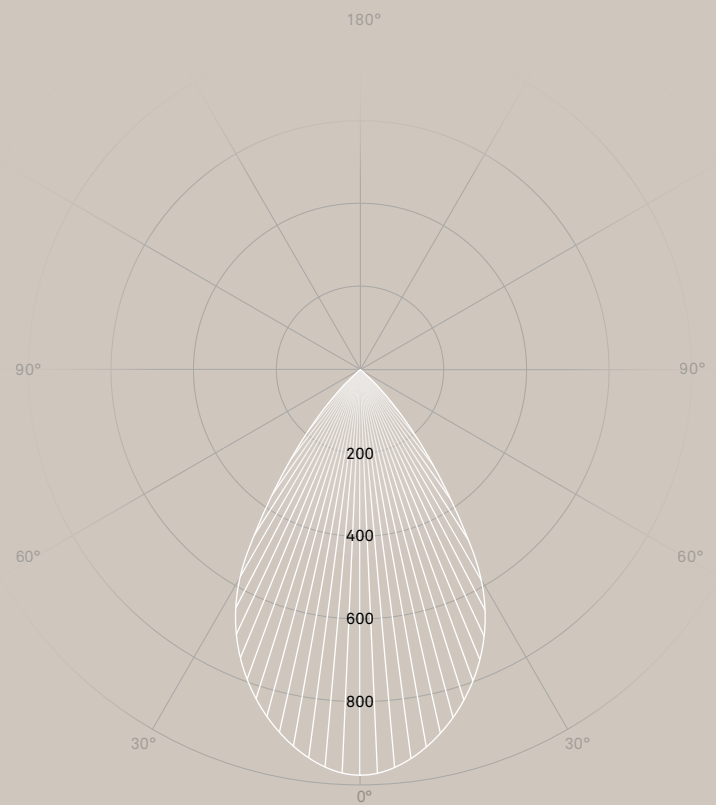
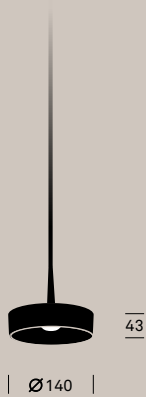

Pendelleuchten
Pendant lamps

Ø 140 mm
mit externem Betriebsgerät
with external control gear

Leuchtengehäuse Lamp housing	Alu-Druckguss Diecast aluminium
Farben Colours	schwarz RAL 9005 / grau RAL 9006 / weiss RAL 9003, Wechselblenden in verschiedenen Farben, separat bestellen black RAL 9005 / grey RAL 9006 / white RAL 9003, Interchangeable shades in different colours, order separately
Farbtemperaturen Colour temperatures	2700 / 3000 / 4000 / 2200–5000 K
Leuchtenlichtstrom Luminaire luminous flux	630–1350 lm
Anschlussleistung Connected load	11–12 W
Nutzlebensdauer LED Service life LED	50'000 h L90 B10 (Ta 25 °C)
Betriebsgerät Control gear	EVG 230 V / 50 Hz, Konstantstrom 700 mA / DT8 600 mA (Betriebsgerät separat bestellen) PS 230 V / 50 Hz, constant current 700 mA / DT8 600 mA (order control gear separately)
Lichtregelung Lighting control	Ein / Aus, PhasenDIM, DALI / TouchDIM, DALI DT8 On / Off, phase-cut, DALI / TouchDIM, DALI DT8

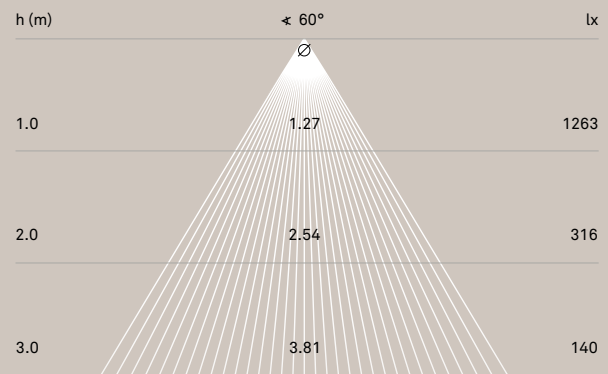

Zur Montage an Decke,
(Pflichtzubehör separat bestellen)
For mounting on the ceiling,
(order essential accessories separately)

Hochwertige Glaslinsen-Technologie mit Ausstrahlwinkel 60°
High-quality glass lens technology with a beam angle of 60°

Pflichtzubehör: Wechselblenden, Baldachin mit Betriebsgerät, Tragschiene für 2 oder 3 Pendelleuchten, externe Betriebsgeräte
Essential accessories: Interchangeable shades, canopy with control gear, mounting rails for 2 or 3 pendant lamps, external control gears

Optionales Zubehör: Hohlräumadapter
Optional accessories: Cavity adapter

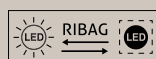

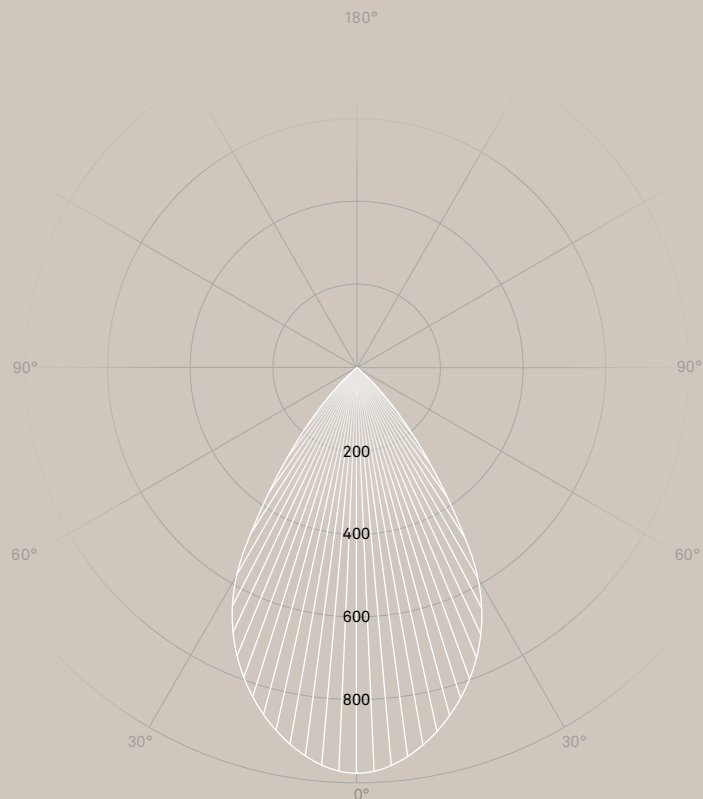
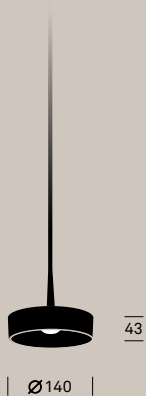

C90 / C270 ————

C0 / C180 |||||

cd / 1000 lm



Pendelleuchten
Pendant lamps

Ø 140 mm AC (230 V)

Leuchtengehäuse
Lamp housing

Alu-Druckguss
Diecast aluminium

Farben
Colours

schwarz RAL 9005 / grau RAL 9006 / weiss RAL 9003,
Wechselblenden in verschiedenen Farben, separat bestellen
black RAL 9005 / grey RAL 9006 / white RAL 9003,
Interchangeable shades in different colours, order separately

Farbtemperaturen
Colour temperatures

2700 / 3000 / 4000 K (auf Anfrage)
2700 / 3000 / 4000 K (on request)

Leuchtenlichtstrom
Luminaire luminous flux

920 lm

Anschlussleistung
Connected load

12 W

Nutzlebensdauer LED
Service life LED

50'000 h L90 B10 (Ta 25 °C)

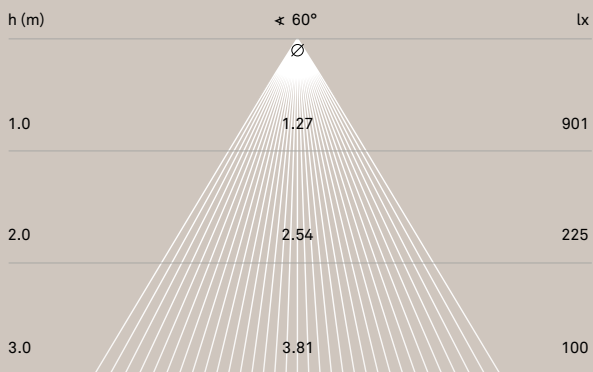

Zur Montage an Decke und Anschluss an 230 V AC / 50 Hz Netzspannung, dimmbar via LED-Phasendimmer, Kabel Ø5 mm, Länge 2500 mm (Liste kompatibler Dimmer: ribag.com/downloads)

For mounting on the ceiling and connection to 230 V AC / 50 Hz mains voltage, dimmable with LED-phase-cut dimmer, cable Ø5 mm, length 2500 mm (List of compatible dimmers: ribag.com/downloads)

Hochwertige Glaslinsen-Technologie mit Ausstrahlwinkel 60°
High-quality glass lens technology with a beam angle of 60°

Pflichtzubehör: Wechselblenden, Baldachin, Tragschienen für 2 oder 3 Pendelleuchten
Essential accessories: Interchangeable shades, canopy, mounting rails for 2 or 3 pendant lamps,

Optionales Zubehör: Hohlraumadapter
Optional accessories: Cavity adapter

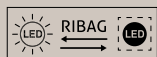

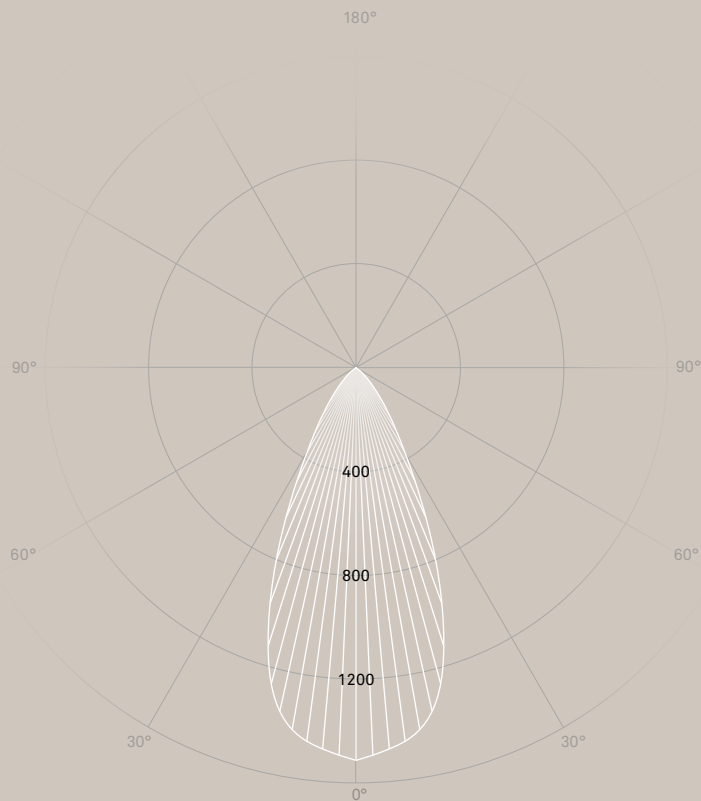

C90 / C270 ————
 C0 / C180 |||||

cd / 1000 lm

CRI >90 UGR ≤16 SDCM2

Deckenleuchten
 Ceiling lamps

Ø270 mm

Leuchtgehäuse Lamp housing	Alu-Druckguss Diecast aluminium
Farben Colours	schwarz RAL 9005 / grau RAL 9006 / weiss RAL 9003, Wechselblenden in verschiedenen Farben, separat bestellen black RAL 9005 / grey RAL 9006 / white RAL 9003, Interchangeable shades in different colours, order separately
Farbtemperaturen Colour temperatures	2700 / 3000 / 4000 K
Leuchtenlichtstrom Luminaire luminous flux	1400–2400 lm
Anschlussleistung Connected load	20–27 W
Nutzlebensdauer LED Service life LED	50'000 h L90 B10 (Ta 25 °C)
Betriebsgerät Control gear	EVG 230 V / 50 Hz PS 230 V / 50 Hz
Lichtregelung Lighting control	Ein / Aus, PhasenDIM, DALI / TouchDIM On / Off, phase-cut, DALI / TouchDIM

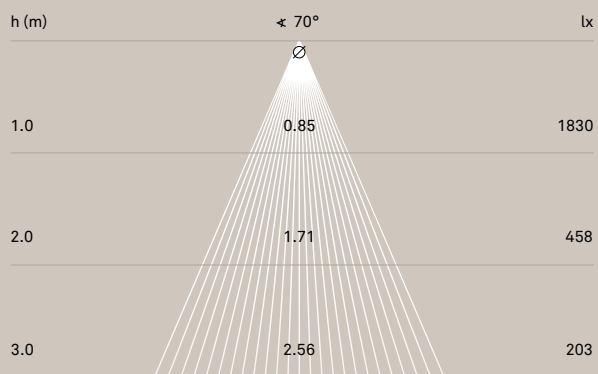

Zur Montage an Decke,
 (Pflichtzubehör separat
 bestellen)

For mounting on the ceiling,
 (order essential accessories
 separately)

Hochwertige Glaslinsen-Technologie mit Ausstrahlwinkel 70°
 High-quality glass lens technology with a beam angle of 70°

Pflichtzubehör:
Wechselblenden
 Essential accessories:
 Interchangeable shades



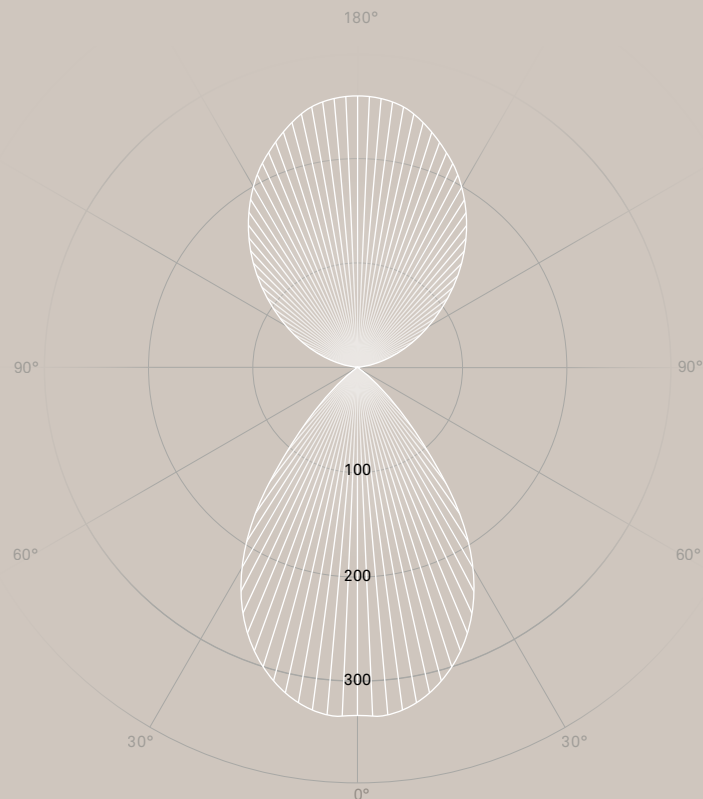
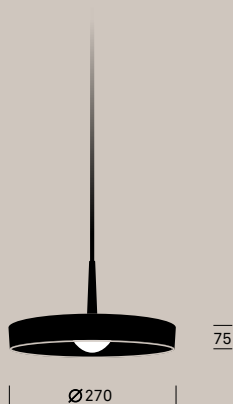

C90 / C270 ————
C0 / C180 |||||

cd / 1000 lm

CRI >90 UGR ≤10 SDCM2

Pendelleuchten
Pendant lamps

Ø270 mm
mit externem Betriebsgerät
with external control gear

Leuchtengehäuse Lamp housing	Alu-Druckguss Diecast aluminium
Farben Colours	schwarz RAL 9005 / grau RAL 9006 / weiss RAL 9003, Wechselblenden in verschiedenen Farben, separat bestellen black RAL 9005 / grey RAL 9006 / white RAL 9003, Interchangeable shades in different colours, order separately
Farbtemperaturen Colour temperatures	2700 / 3000 / 4000 / 2200–5000 K
Leuchtenlichtstrom Luminaire luminous flux	1315–2520 lm
Anschlussleistung Connected load	22–28 W
Nutzlebensdauer LED Service life LED	50'000 h L90 B10 (Ta 25 °C)
Betriebsgerät Control gear	EVG 230 V / 50 Hz, Konstantstrom 700 mA / DT8 600 mA (Betriebsgerät separat bestellen) PS 230 V / 50 Hz, constant current 700 mA / DT8 850 mA (order control gear separately)
Lichtregelung Lighting control	Ein / Aus, PhasenDIM, DALI / TouchDIM, DALI DT8 On / Off, phase-cut, DALI / TouchDIM, DALI DT8

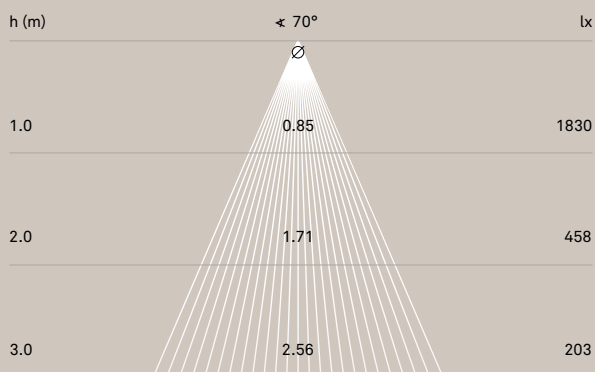

Zur Montage an Decke,
(Pflichtzubehör separat
bestellen)
For mounting on the ceiling,
(order essential accessories
separately)

Pflichtzubehör: Wechselblenden,
Baldachin mit Betriebs-
gerät, Tragschiene für 2 oder
3 Pendelleuchten, externe
Betriebsgeräte
Essential accessories:
Interchangeable shades,
canopy with control gear,
mounting rails for 2 or
3 pendant lamps, external
control gears

Hochwertige Glaslinsen-Technologie mit Ausstrahlwinkel
70°, 50% direkt-, 50% indirekt
strahlend
High-quality glass lens technology
with a beam angle
of 70°, 50 % direct-, 50 %
indirect beam

Optionales Zubehör:
Hohlraumadapter
Optional accessories:
Cavity adapter

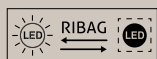

IMPRESSUM IMPRINT



ribag.com



[@ribaglight](https://www.instagram.com/ribaglight)



[ribaglight](https://www.facebook.com/ribaglight)

Headquarters

RIBAG Licht AG
Kanalstrasse 18
5745 Safenwil
Switzerland
Tel +41 62 737 90 10 (Sales)
Tel +41 62 737 50 70 (Service)
info@ribag.com
www.ribag.com

© RIBAG Licht AG
Lighting Collection 2024
Subject to modifications

