

RIBAG



MILUM

/  
essence of light

# MILUM

RIBAG Design Studio

Das multifunktionale Lichtsystem MILUM zeichnet sich durch detailgetreue Verarbeitung, durchgängige Formensprache und die Verwendung hochwertiger Materialien aus. Mit drei kombinierbaren Modulen (Lightline, Downlight, Wallwasher) planen Sie diffuse Allgemeinbeleuchtung oder brillantes Akzentlicht, frei in der Form und Montagevariante. MILUM eröffnet einen grösstmöglichen Gestaltungsspielraum und ist ein effektvolles Werkzeug für nutzerspezifische und wirkungsvolle Beleuchtungskonzepte im hochwertigen Wohn- und Objektbereich.

The multifunctional light system MILUM excels with its detailed processing, consistent styling and use of high-quality materials. Three combinable modules (Lightline, Downlight and Wallwasher) allow you to plan diffuse general lighting or brilliant accent lighting, with a free choice of form and installation. MILUM opens up maximum design scope and is an effective tool for user-specific and impressive lighting concepts in premium living spaces and real estate.

[ribag.com/milum](https://ribag.com/milum)



reddot winner 2020

#### **MILUM Lightline**

In unserem Online Konfigurator planen Sie Licht nach Mass auf den Millimeter genau. MILUM Lightline bietet perfekt homogenes Licht ohne Schattenbildung

#### **MILUM lightline**

In our online configurator, you can plan custom-made light per millimetre. MILUM lightline provides perfectly homogeneous light without casting shadows



#### **MILUM Wallwasher**

Erleben Sie eine Wandbeleuchtung direkt ab Deckenkante mit gleichmässiger Lichtverteilung ohne Streuverlust. Der MILUM Wallwasher bietet zudem eine sehr gute Entblendung in Längsrichtung

#### **MILUM wallwasher**

Experience wall lighting directly from the ceiling edge with even light distribution without stray light loss. The MILUM wallwasher offers excellent anti-glare in the longitudinal direction

#### **MILUM Downlight**

Durch den Einsatz von Doppel-fokuslinsen bietet das MILUM Downlight absolut blendfreies Licht in wählbaren Ausstrahlwinkeln von 30° oder 60° mit präzisiertem Cut-off. Die verschiedenen Module überzeugen mit hoher Lichtstärke auf kleinstem Raum

#### **MILUM downlight**

Thanks to the use of double-focus lenses, the MILUM downlight offers absolutely glare-free light with a selectable beam angle of 30° or 60° with precise cut-off. The various modules provide impressive high luminous intensity in the smallest of space





**MILUM** Anbauleuchte  
mit opalem Diffusor  
**MILUM** mounted lamp  
with opal diffuser









Kombiniertes **MILUM** Pendel-  
leuchtensystem mit Downlight  
Modulen und **KIVO** Pendelleuchten  
Combined **MILUM** pendant light  
system with downlight modules and  
**KIVO** pendant lamps



**MILUM** Lightline mit Diffusor opal;  
in Kombination mit **MILUM**  
Wallwasher-Modulen  
**MILUM** lightline with opal diffuser;  
combined with **MILUM**  
wallwasher modules





Kombiniertes **MILUM** Deckenleuchtensystem mit Downlight-Modulen und opalem Diffusor; **SPARK** mit Abdeckring

Combined **MILUM** ceiling lamps system with downlight modules and opal diffuser; **SPARK** with cover ring







**MILUM** Pendelleuchten mit  
Downlight Modulen, kombiniert  
mit **SPARK** Wallwasher  
MILUM pendant lamps with  
downlight modules, combined  
with **SPARK** wallwasher



**MILUM Deckenleuchtensystem mit Wallwasher-Modulen; in Kombination mit Downlight-Modulen**  
MILUM ceiling lamps system with wallwasher modules; combined with downlight modules



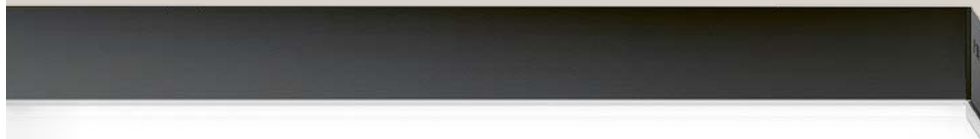

**MILUM Einzelleuchte  
mit Diffusor opal  
rundumstrahlend**  
MILUM Single lamp  
with diffuser opal  
omnidirectional

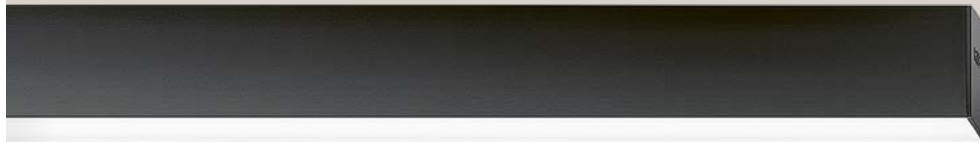

**MILUM Lightline**  
MILUM Lightline



**MILUM Wallwasher**  
MILUM Wallwasher

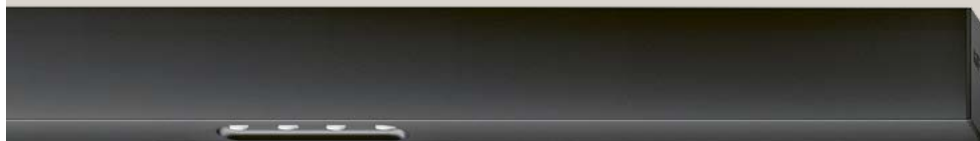

**MILUM Downlight**  
MILUM Downlight

Das Lichtsystem MILUM bietet verschiedenste und flexible Beleuchtungsmöglichkeiten. Durch den modularen Aufbau von Tragschienen und Einsätzen können unterschiedliche Lichtwirkungen kombiniert werden. Das System besteht aus rundumstrahlend-diffusen Modulen, direktstrahlend-diffusen Modulen sowie brillanten Downlights und Wallwashern, nach Wunsch kombinierbar mit Eckverbindern für die Gestaltung diverser Bauformen. Alle Varianten können als Anbau- oder Pendelleuchten eingesetzt werden und verfügen über eine Durchgangsverdrahtung für eine einfache Reihenmontage. Durch die erweiterte Profilhöhe ist eine flexible Anordnung aller Module möglich. Das rundumstrahlend-diffuse Modul ist zusätzlich als Einzelleuchte, ohne Durchgangsverdrahtung und mit einem höhenreduzierten Profil, erhältlich.

The MILUM lighting system offers a wide variety of flexible lighting options. Thanks to the modular design of the mounting rails and inserts, a wide variety of lighting effects can be combined. The system consists of omnidirectional-beam diffuse modules, direct-beam diffuse modules as well as brilliant downlights and wallwashers, which can be combined, if required, with corner connectors for the design of diverse construction shapes. All versions can be used as surface-mounted or pendant lamps and are provided with feed-through wiring for simple series mounting. The extended mounting rail height allows flexible arrangement of all modules. The omnidirectional-beam diffuse module is also available as single lamp, without feed-through wiring and with a height-reduced mounting rail.

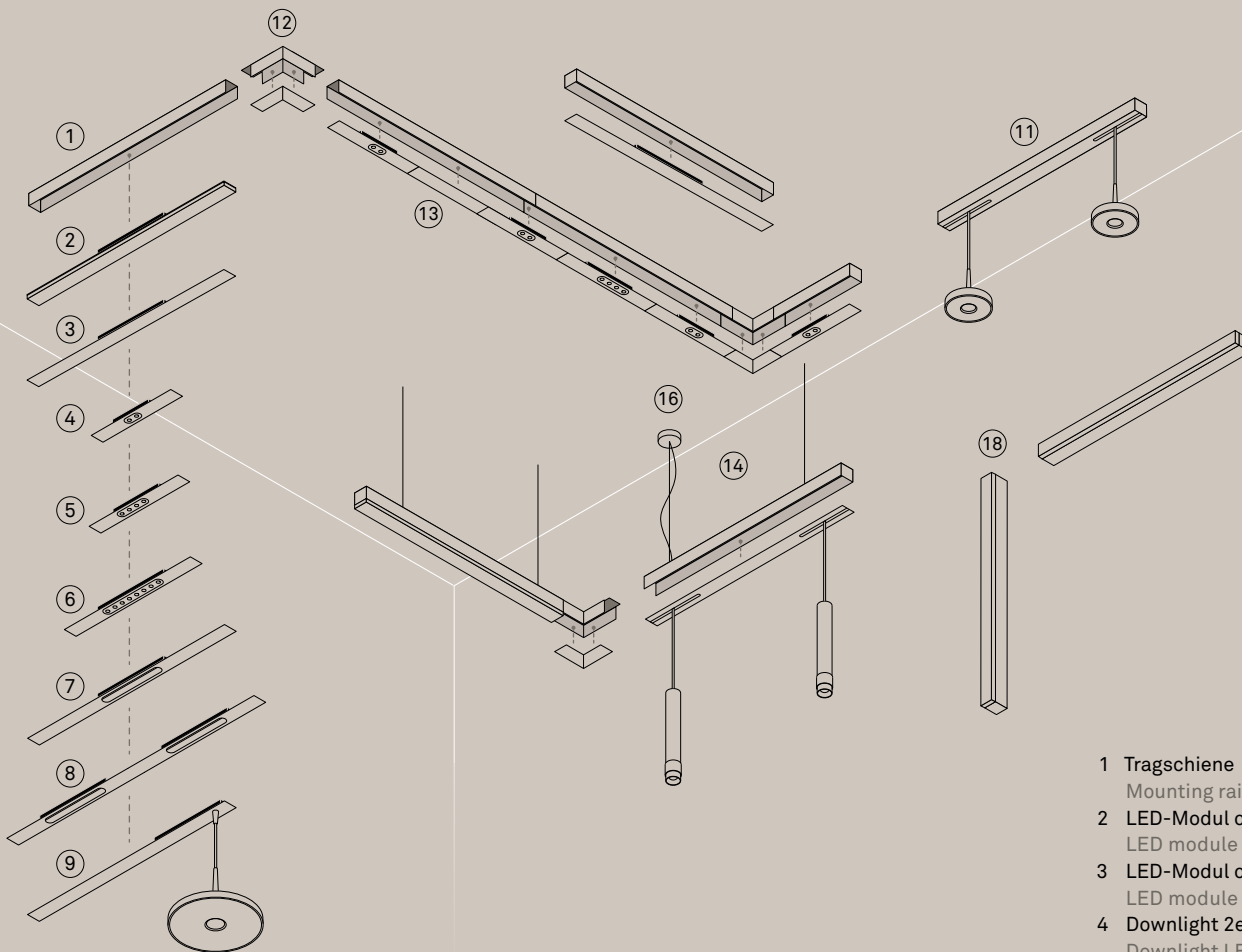

- 1 Tragschiene  
Mounting rail
- 2 LED-Modul opal rundumstrahlend  
LED module opal omnidirectional
- 3 LED-Modul opal direktstrahlend  
LED module opal direct beam
- 4 Downlight 2er LED-Module  
Downlight LED modules of 2
- 5 Downlight 4er LED-Module  
Downlight LED modules of 4
- 6 Downlight 8er LED-Module  
Downlight LED modules of 8
- 7 Wallwasher 8er LED-Module  
Wallwasher LED modules of 8
- 8 Wallwasher 2 x 8er LED-Module  
Wallwasher LED modules of 2 x 8
- 9 Pendelleuchtenelement «DC»  
Pendant lamp element "DC"
- 10 Pendelleuchtenelement «AC»  
Pendant lamp element "AC"
- 11 Tragschiene einstellbar  
Mounting rail adjustable
- 12 Eckverbinder  
Corner connector
- 13 Blindabdeckung  
Blind cover
- 14 Pendel-Set (inkl. Anschlusskabel)  
Pendant set (incl. connecting cable)
- 15 Stahlseilabhängung  
Steel cable suspension
- 16 Baldachin  
Canopy
- 17 Montagebügel-Set  
Mounting bracket set
- 18 Einzelleuchte «Lightline» mit Diffusor opal, rundumstrahlend  
Single lamp "lightline" with diffuser opal, omnidirectional

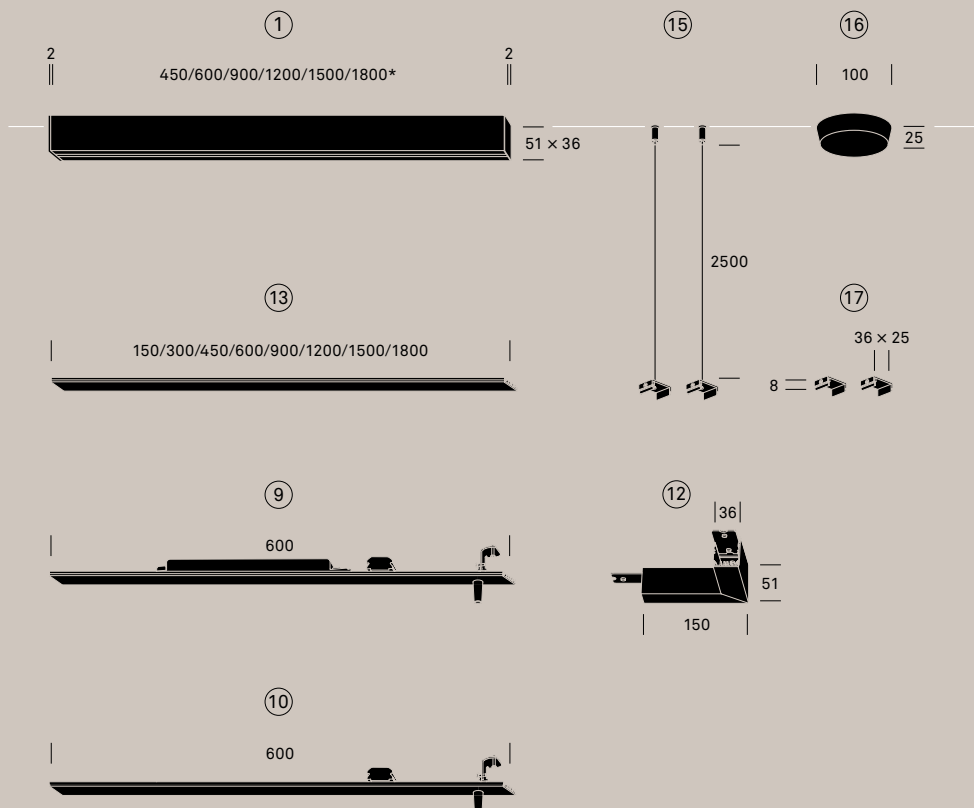

MILUM

\* Länge ohne Endplatten  
Length without end plates

**Planungshinweise:**

Sämtliches Zubehör separat bestellen

**Planning guide:**

Order all accessories separately

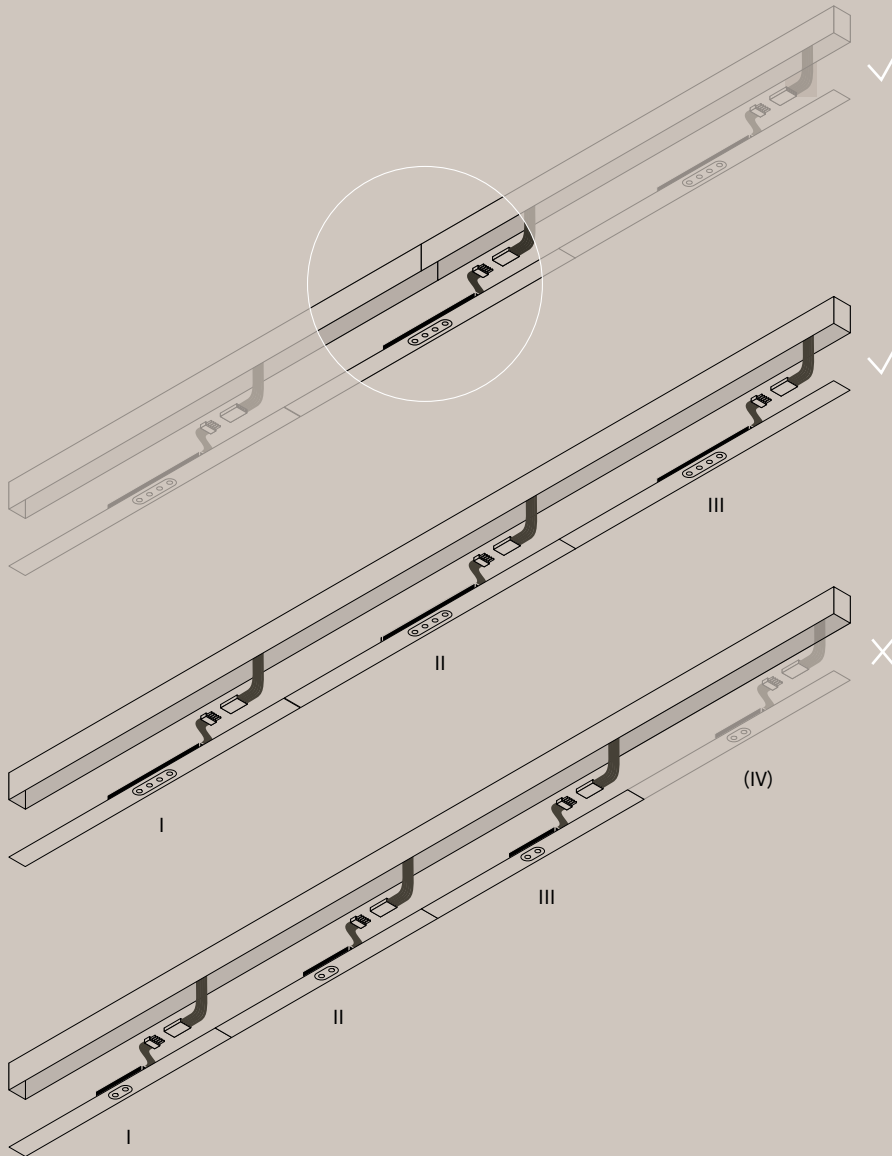

Alle LED-Module können in den Tragschienen flexibel platziert werden, auch über Stossverbindungen hinweg.  
All LED modules can be flexibly placed in the mounting rails, even across mounting rail connections.

Pro Tragschiene, mit einer Länge von 1800 mm, lassen sich maximal drei Module platzieren.

A maximum of three modules can be placed per mounting rail, with a length of 1800 mm.

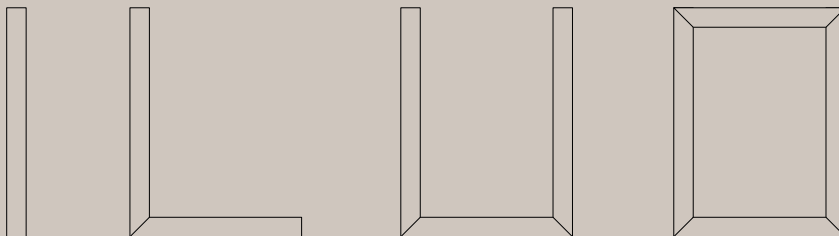

Millimeter-genaue Massanfertigungen mit diffus strahlenden Lightline-Modulen, die Formen I sowie L mit leuchtendem Eckverbinder, können Sie über unseren Online-Konfigurator bestellen. Spezialformen wie U und O realisieren wir auf Anfrage.

Millimetre-precise customized solutions with diffuse Lightline modules in the shapes I so as L with luminous corner corner connector, can be ordered via our online configurator. Special shapes such as U and O are available on request.



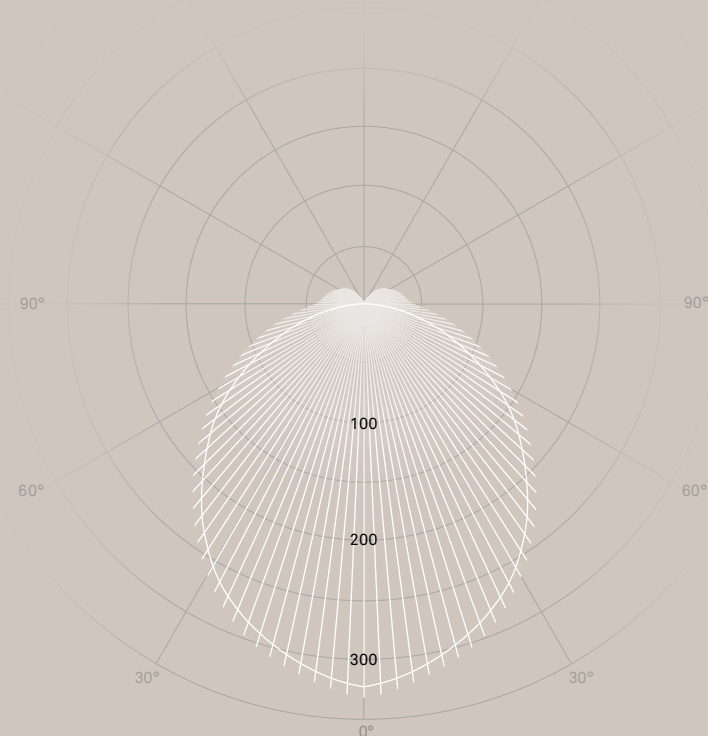
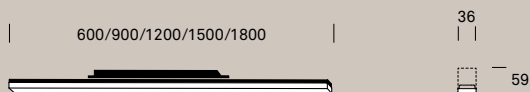

C90 / C270

C0 / C180

cd / 1000 lm



#### LED-Modul zu Lichtsystem LED module for lighting system

#### Modul opal rundumstrahlend Module opal omnidirectional

Farbtemperaturen Colour temperatures	2700 / 3000 / 4000 K
Leuchtenlichtstrom Luminaire luminous flux	960–3200 lm
Anschlussleistung Connected load	11–34 W
Nutzlebensdauer LED Service life LED	50'000 h L90 B10 (Ta 25 °C)
Betriebsgerät Control gear	EVG 230 V / 50 Hz PS 230 V / 50 Hz
Lichtregelung Lighting control	PhasenDIM, DALI / TouchDIM Phase-cut, DALI / TouchDIM

#### Zur werkzeuglosen Montage in Tragschiene (Pflichtzubehör separat bestellen)

For toolless installation on  
mounting rails (order essential  
accessories separately)

#### Kunstglas-Diffusor opal Acrylic glass diffuser opal

#### Anbauleuchten Pflichtzubehör: Tragschienen

Optionales Zubehör:  
Blindabdeckung, Eckverbin-  
der 90°, Montagebügel-Set,  
Pendelleuchtenelemente

#### Mounted lamps

Essential accessories:  
mounting rails

Optional accessories:  
blind cover, corner connec-  
tor 90°, mounting bracked set,  
pendant lamps elements

#### Pendelleuchten

Pflichtzubehör: Tragschienen,  
Pendel-Set

Optionales Zubehör:  
Baldachin, Blindabdeckung,  
Eckverbinder 90°, Anschluss-  
kabel, Stahlseilabhangung,  
Pendelleuchtenelemente

#### Pendant lamps

Essential accessories:  
mounting rails, pendant set  
Optional accessories:  
canopy, blind cover, corner  
connector 90°, connecting  
cable, steel cable suspension,  
pendant lamp elements



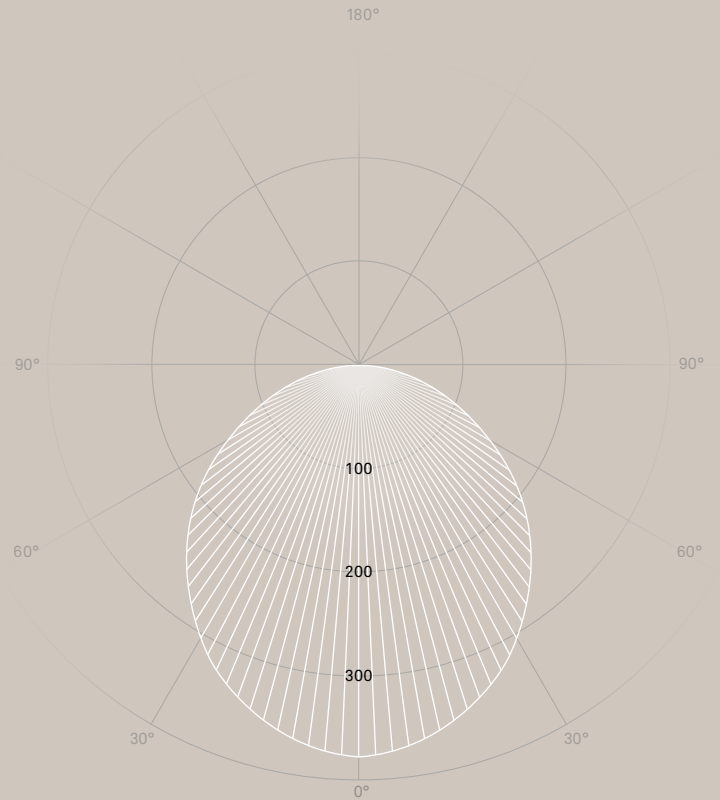
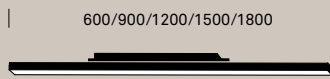

C90 / C270 ————  
C0 / C180 |||

cd / 1000 lm



**LED-Modul zu  
Lichtsystem**  
LED module for  
lighting system

**Modul opal direktstrahlend**  
Module opal direct-beam

Farbtemperaturen Colour temperatures	2700 / 3000 / 4000 K
Leuchtenlichtstrom Luminaire luminous flux	900–3010 lm
Anschlussleistung Connected load	11–34 W
Nutzlebensdauer LED Service life LED	50'000 h L90 B10 (Ta 25 °C)
Betriebsgerät Control gear	EVG 230 V / 50 Hz PS 230 V / 50 Hz
Lichtregelung Lighting control	PhasenDIM, DALI / TouchDIM Phase-cut, DALI / TouchDIM

Zur werkzeuglosen Montage  
in Tragschiene (Pflichtzubehör  
separat bestellen)  
For toolless installation on  
mounting rails (order essential  
accessories separately)

Kunstglas-Diffusor opal  
Acrylic glass diffuser opal

**Anbauleuchten**  
Pflichtzubehör:  
Tragschienen  
Optionales Zubehör:  
Blindabdeckung, Eckverbin-  
der 90°, Montagebügel-Set,  
Pendelleuchtenelemente

**Mounted lamps**  
Essential accessories:  
mounting rails  
Optional accessories:  
blind cover, corner connec-  
tor 90°, mounting bracket set,  
pendant lamps elements

**Pendelleuchten**  
Pflichtzubehör: Tragschienen,  
Pendel-Set  
Optionales Zubehör:  
Baldachin, Blindabdeckung,  
Eckverbinder 90°, Anschluss-  
kabel, Stahlseilabhängung,  
Pendelleuchtenelemente



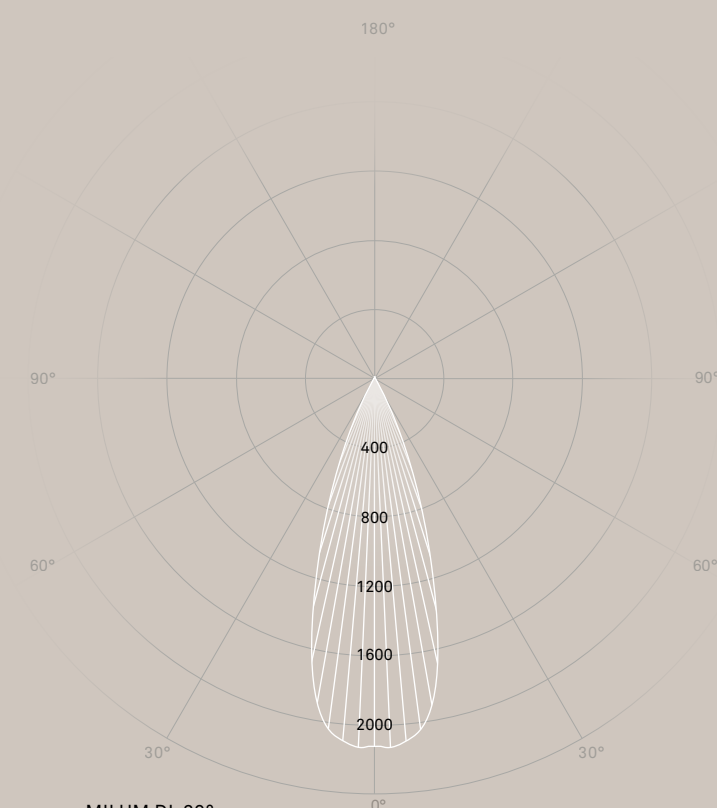

MILUM DL 30°

C90 / C270 ———  
C0 / C180 |||||

cd / 1000 lm



**LED-Modul zu Lichtsystem**  
LED module for lighting system

**Downlight 2er Modul**  
Downlight module of 2

<b>Material</b> Material	Alu-Strangpress Extruded aluminium
<b>Farben</b> Colours	farblos eloxiert / schwarz RAL 9005 / weiss RAL 9003 natural anodised / black RAL 9005 / white RAL 9003
<b>Farbtemperaturen</b> Colour temperatures	2700 / 3000 / 4000 / 2200–5000 K
<b>Leuchtenlichtstrom</b> Luminaire luminous flux	285–310 lm
<b>Anschlussleistung</b> Connected load	6 W
<b>Nutzlebensdauer LED</b> Service life LED	50'000 h L90 B10 (Ta 25 °C)
<b>Betriebsgerät</b> Control gear	EVG 230 V / 50 Hz PS 230 V / 50 Hz
<b>Lichtregelung</b> Lighting control	PhasenDIM, DALI / TouchDIM / DALI DT8 Phase-cut, DALI / TouchDIM / DALI DT8

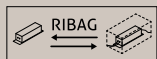
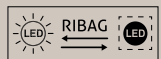
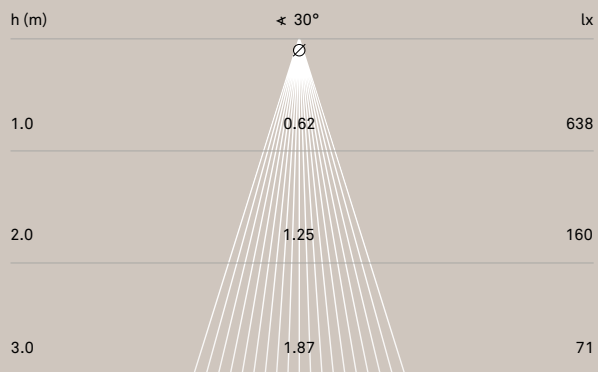



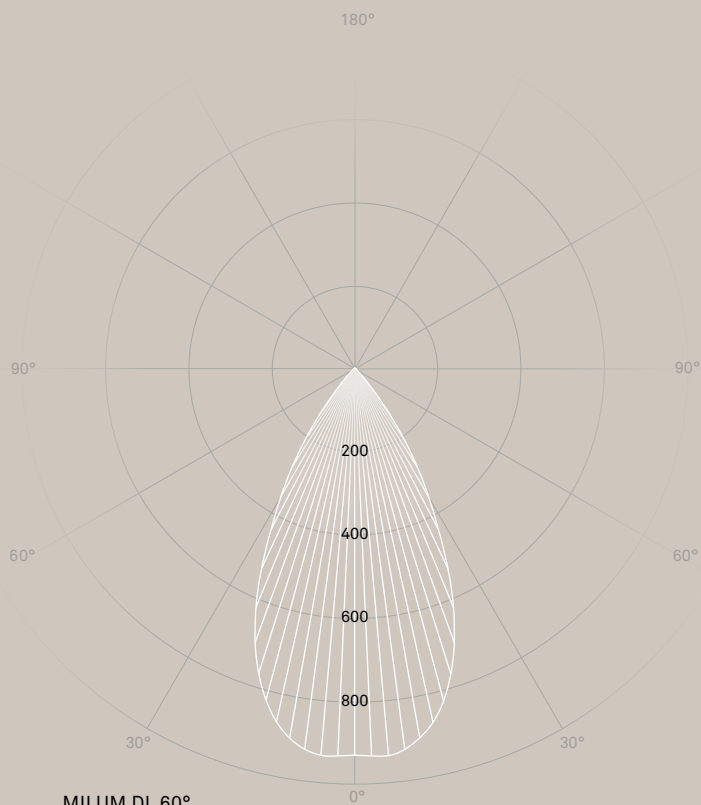

MILUM DL 60°

C90 / C270 ———  
 C0 / C180 |||||

cd / 1000 lm

CRI >90    UGR ≤19    SDCM2

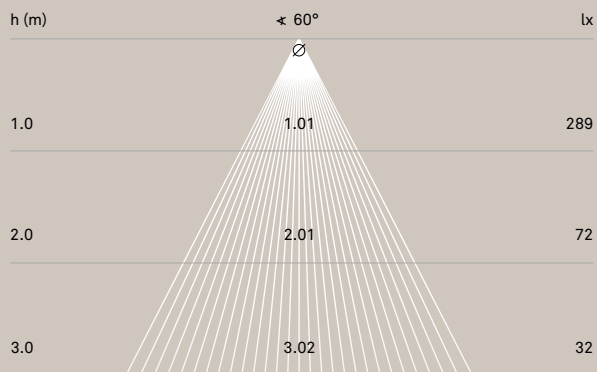

Zur werkzeuglosen Montage in Tragschiene (Pflichtzubehör separat bestellen)  
 For toolless installation on mounting rails (order essential accessories separately)

**Hochwertige Linsen-Lichttechnik**  
 High-quality lens lighting technology

**Anbauleuchten**  
 Pflichtzubehör: Tragschienen  
 Optionales Zubehör: Blindabdeckung, Eckverbinder 90°, Montagebügel-Set, Pendelleuchtelemente,  
**Mounted lamps**  
 Essential accessories: mounting rails  
 Optional accessories: blind cover, corner connector 90°, mounting bracketed set, pendant lamps elements

**Pendelleuchten**  
 Pflichtzubehör: Tragschienen, Pendel-Set  
 Optionales Zubehör: Baldachin, Blindabdeckung, Eckverbinder 90°, Anschlusskabel, Stahlseilabhängung, Pendelleuchtelemente  
**Pendant lamps**  
 Essential accessories: mounting rails, pendant set  
 Optional accessories: canopy, blind cover, corner connector 90°, connecting cable, steel cable suspension, pendant lamps elements

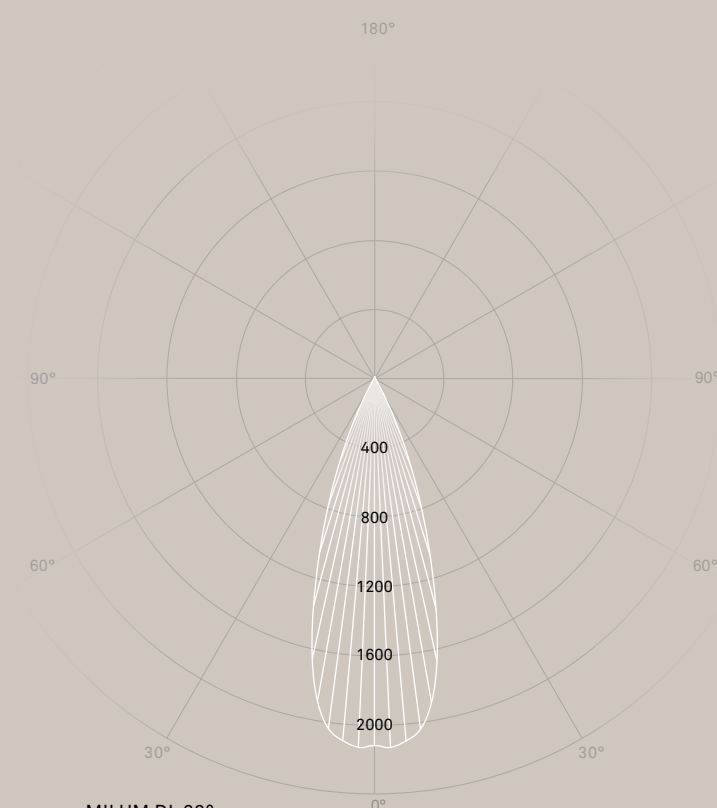
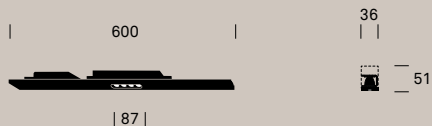

MILUM DL 30°



**LED-Modul zu Lichtsystem**  
LED module for lighting system

**Downlight 4er Modul**  
Downlight module of 4

<b>Material</b> Material	Alu-Strangpress Extruded aluminium
<b>Farben</b> Colours	farblos eloxiert / schwarz RAL 9005 / weiss RAL 9003 natural anodised / black RAL 9005 / white RAL 9003
<b>Farbtemperaturen</b> Colour temperatures	2700 / 3000 / 4000 / 2200–5000 K
<b>Leuchtenlichtstrom</b> Luminaire luminous flux	565–620 lm
<b>Anschlussleistung</b> Connected load	12 W
<b>Nutzlebensdauer LED</b> Service life LED	50'000 h L90 B10 (Ta 25 °C)
<b>Betriebsgerät</b> Control gear	EVG 230 V / 50 Hz PS 230 V / 50 Hz
<b>Lichtregelung</b> Lighting control	PhasenDIM, DALI / TouchDIM / DALI DT8 Phase-cut, DALI / TouchDIM / DALI DT8

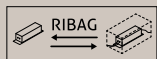
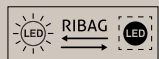
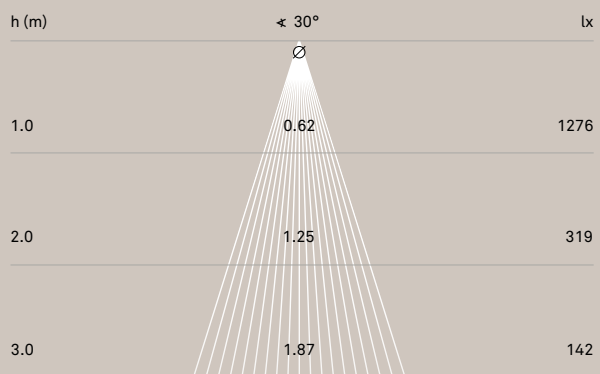

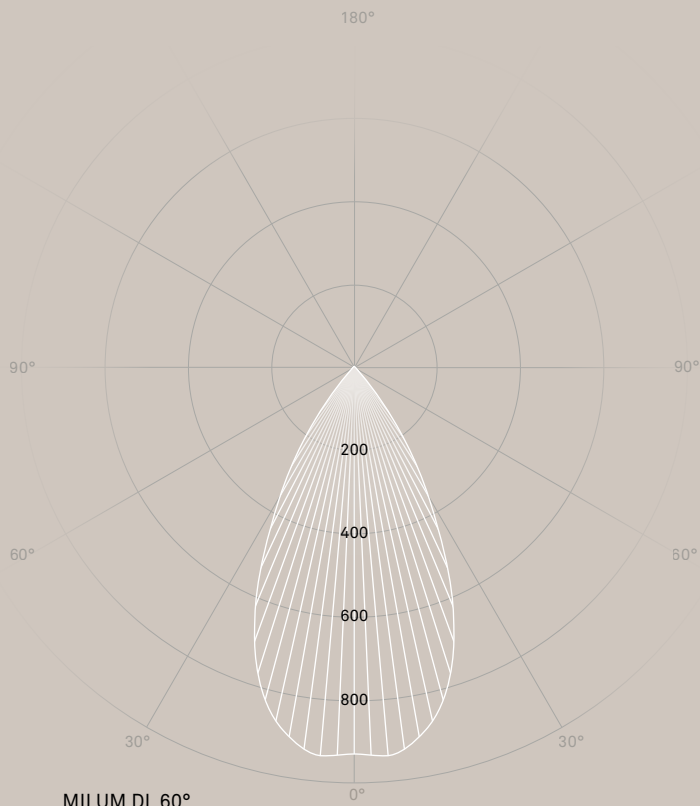

MILUM DL 60°

C90 / C270 ———  
 C0 / C180 |||||

cd / 1000 lm

CRI >90    UGR ≤19    SDCM2

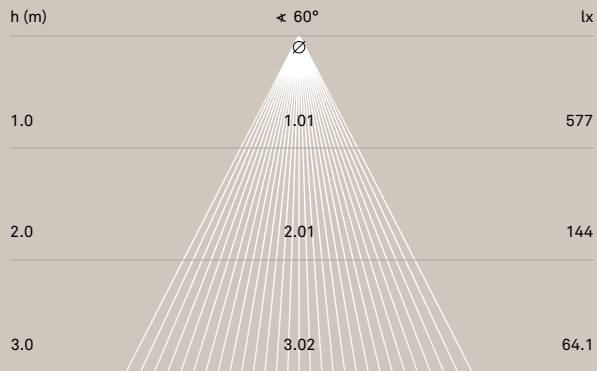

Zur werkzeuglosen Montage in Tragschiene (Pflichtzubehör separat bestellen)

For toolless installation on mounting rails (order essential accessories separately)

**Hochwertige Linsen-Lichttechnik**

High-quality lens lighting technology

**Anbauleuchten**

**Pflichtzubehör:**

Tragschienen

Optionales Zubehör:

Blindabdeckung, Eckverbinder 90°, Montagebügel-Set, Pendelleuchtelemente

**Mounted lamps**

Essential accessories:

mounting rails

Optional accessories:

blind cover, corner connector 90°, mounting bracketed set, pendant lamps elements

**Pendelleuchten**

**Pflichtzubehör:** Tragschienen, Pendel-Set

Optionales Zubehör:

Baldachin, Blindabdeckung, Eckverbinder 90°, Anschlusskabel, Stahlseilabhangung, Pendelleuchtelemente

**Pendant lamps**

Essential accessories:

mounting rails, pendant set

Optional accessories:

canopy, blind cover, corner connector 90°, connecting cable, steel cable suspension, pendant lamps elements



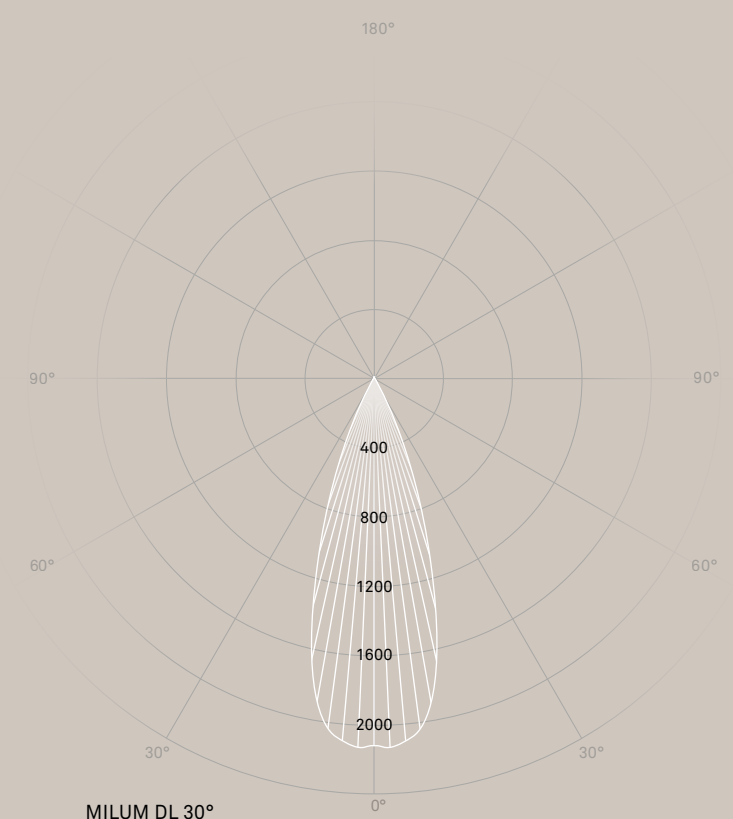
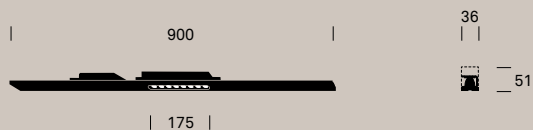

MILUM DL 30°



**LED-Modul zu Lichtsystem**  
LED module for lighting system

**Downlight 8er Modul**  
Downlight module of 8

<b>Material</b> Material	Alu-Strangpress Extruded aluminium
<b>Farben</b> Colours	farblos eloxiert / schwarz RAL 9005 / weiss RAL 9003 natural anodised / black RAL 9005 / white RAL 9003
<b>Farbtemperaturen</b> Colour temperatures	2700 / 3000 / 4000 / 2200–5000 K
<b>Leuchtenlichtstrom</b> Luminaire luminous flux	810–1240 lm
<b>Anschlussleistung</b> Connected load	15–20 W
<b>Nutzlebensdauer LED</b> Service life LED	50'000 h L90 B10 (Ta 25 °C)
<b>Betriebsgerät</b> Control gear	EVG 230 V / 50 Hz PS 230 V / 50 Hz
<b>Lichtregelung</b> Lighting control	PhasenDIM, DALI / TouchDIM / DALI DT8 Phase-cut, DALI / TouchDIM / DALI DT8

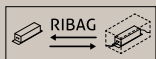
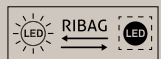
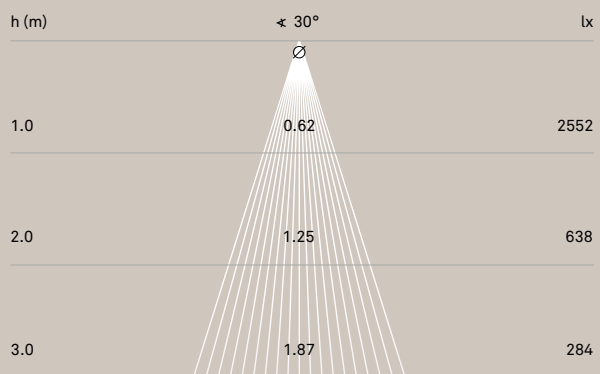

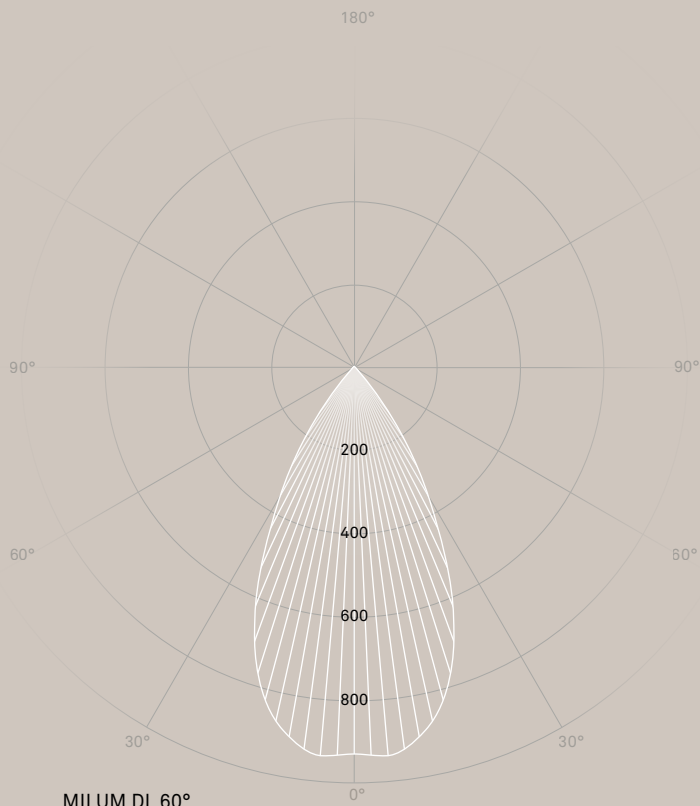

MILUM DL 60°

C90 / C270 ———  
 C0 / C180 |||||

cd / 1000 lm

CRI >90    UGR ≤19    SDCM2

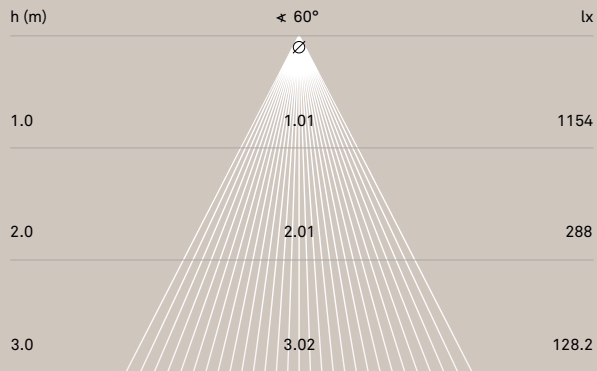

Zur werkzeuglosen Montage in Tragschiene (Pflichtzubehör separat bestellen)

For toolless installation on mounting rails (order essential accessories separately)

**Hochwertige Linsen-Lichttechnik**

High-quality lens lighting technology

**Anbauleuchten**

**Pflichtzubehör:**

Tragschienen

Optionales Zubehör:

Blindabdeckung, Eckverbinder 90°, Montagebügel-Set,

Pendelleuchtelemente,

**Mounted lamps**

Essential accessories:

mounting rails

Optional accessories:

blind cover, corner connector 90°, mounting bracketed set,

pendant lamps elements

**Pendelleuchten**

**Pflichtzubehör:** Tragschienen, Pendel-Set

Optionales Zubehör:

Baldachin, Blindabdeckung,

Eckverbinder 90°, Anschlusskabel, Stahlseilabhängung,

Pendelleuchtelemente

**Pendant lamps**

Essential accessories:

mounting rails, pendant set

Optional accessories:

canopy, blind cover, corner

connector 90°, connecting

cable, steel cable suspension,

pendant lamps elements,

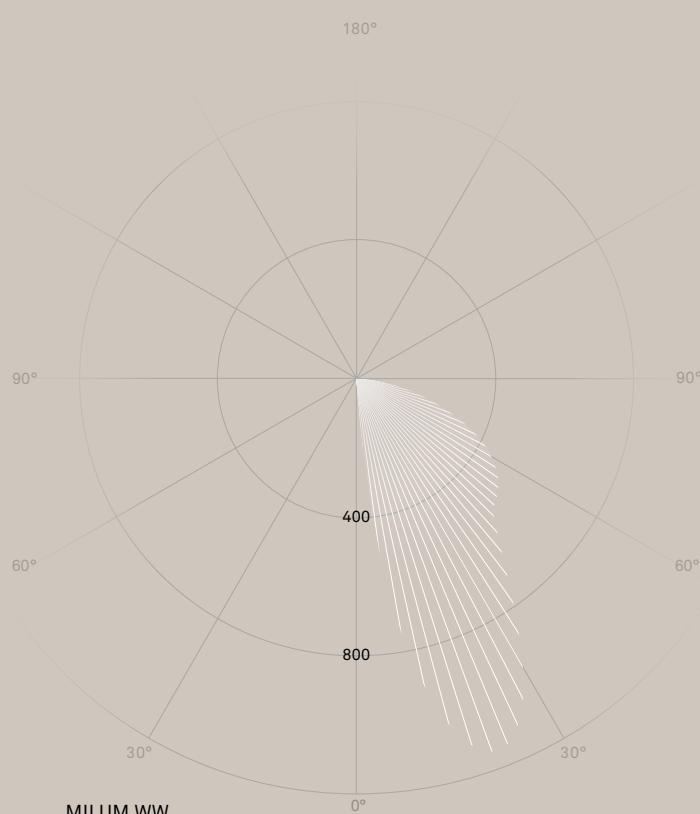

MILUM WW

C0/C180

cd / 1000 lm

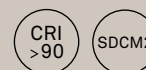

**LED-Modul zu  
Lichtsystem**  
LED module for  
lighting system

**Wallwasher 8er Modul**  
Wallwasher module of 8

Material Material	Alu-Strangpress Extruded aluminium
Farben Colours	farblos eloxiert / schwarz RAL 9005 / weiss RAL 9003 natural anodised / black RAL 9005 / white RAL 9003
Farbtemperaturen Colour temperatures	2700 / 3000 / 4000 / 2200–5000 K
Leuchtenlichtstrom Luminaire luminous flux	590–720 lm
Anschlussleistung Connected load	10–12 W
Nutzlebensdauer LED Service life LED	50'000 h L90 B10 (Ta 25 °C)
Betriebsgerät Control gear	EVG 230 V / 50 Hz PS 230 V / 50 Hz
Lichtregelung Lighting control	PhasenDIM, DALI / TouchDIM / DALI DT8 Phase-cut, DALI / TouchDIM / DALI DT8

Zur werkzeuglosen Montage  
in Tragschiene (Pflichtzubehör  
separat bestellen)

For toolless installation on  
mounting rails (order essen-  
tial accessories separately)

Hochwertige  
Microfacetten-Lichttechnik  
High-quality micro faceted  
lighting technology

**Anbauleuchten**

Pflichtzubehör:  
Tragschienen  
Optionales Zubehör:  
Blindabdeckung, Eckverbin-  
der 90°, Montagebügel-Set,  
Pendelleuchtenelemente

**Mounted lamps**

Essential accessories:  
mounting rails  
Optional accessories:  
blind cover, corner connec-  
tor 90°, mounting bracked set,  
pendant lamps elements

**Pendelleuchten**

Pflichtzubehör: Tragschienen,  
Pendel-Set

Optionales Zubehör:  
Baldachin, Blindabdeckung,  
Eckverbinder 90°, Anschluss-  
kabel, Stahlseilabhängung,  
Pendelleuchtenelemente

**Pendant lamps**

Essential accessories:  
mounting rails, pendant set  
Optional accessories:  
canopy, blind cover, corner  
connector 90°, connecting  
cable, steel cable suspension,  
pendant lamps elements

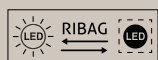



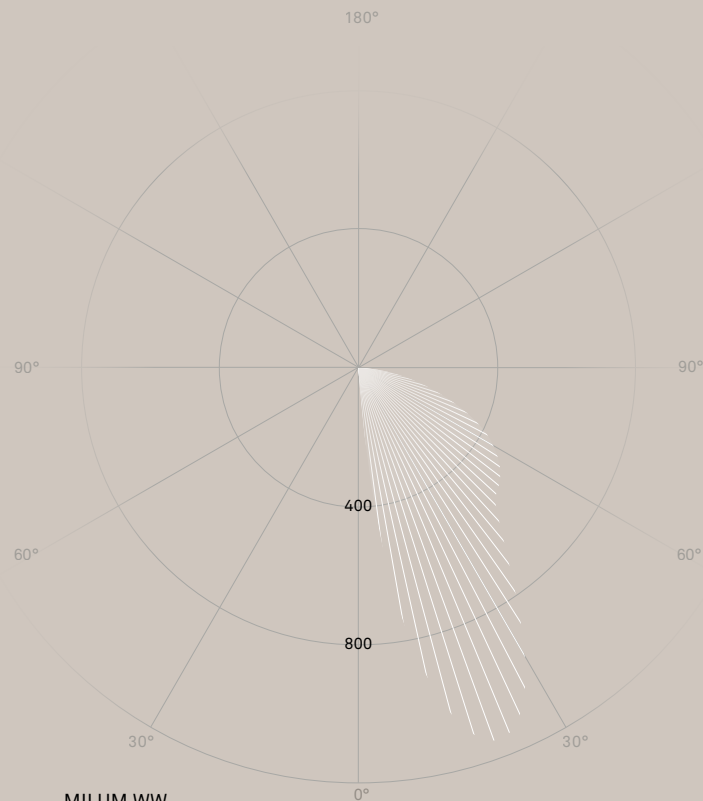
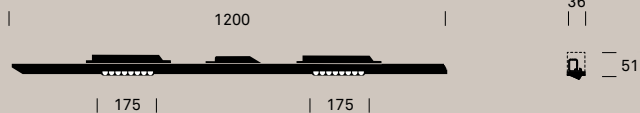

MILUM WW

C0/C180

cd / 1000 lm

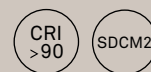

**LED-Modul zu Lichtsystem**  
LED module for lighting system

**Wallwasher 2 x 8er Modul**  
Wallwasher module of 2 x 8

<b>Material</b> Material	<b>Alu-Strangpress</b> Extruded aluminium
<b>Farben</b> Colours	farblos eloxiert / schwarz RAL 9005 / weiss RAL 9003 natural anodised / black RAL 9005 / white RAL 9003
<b>Farbtemperaturen</b> Colour temperatures	2700 / 3000 / 4000 / 2200–5000 K
<b>Leuchtenlichtstrom</b> Luminaire luminous flux	1180–1440 lm
<b>Anschlussleistung</b> Connected load	20–22 W
<b>Nutzlebensdauer LED</b> Service life LED	50'000 h L90 B10 (Ta 25 °C)
<b>Betriebsgerät</b> Control gear	EVG 230 V / 50 Hz PS 230 V / 50 Hz
<b>Lichtregelung</b> Lighting control	PhasenDIM, DALI / TouchDIM / DALI DT8 Phase-cut, DALI / TouchDIM / DALI DT8

**Planungshinweise:**  
gleichmässige Ausleuchtung  
Planning guide:  
homogeneity of illumination

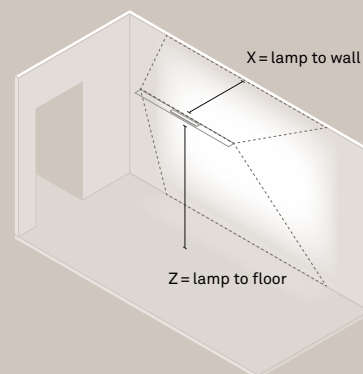

Z	X=1 m
3 m	exzellent excellent
4 m	exzellent excellent
5 m	sehr gut very good

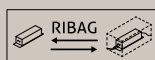
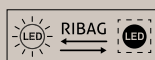

604/904/1204/1504/1804



36  
||  
51 ■ ■ ■ 43  
8

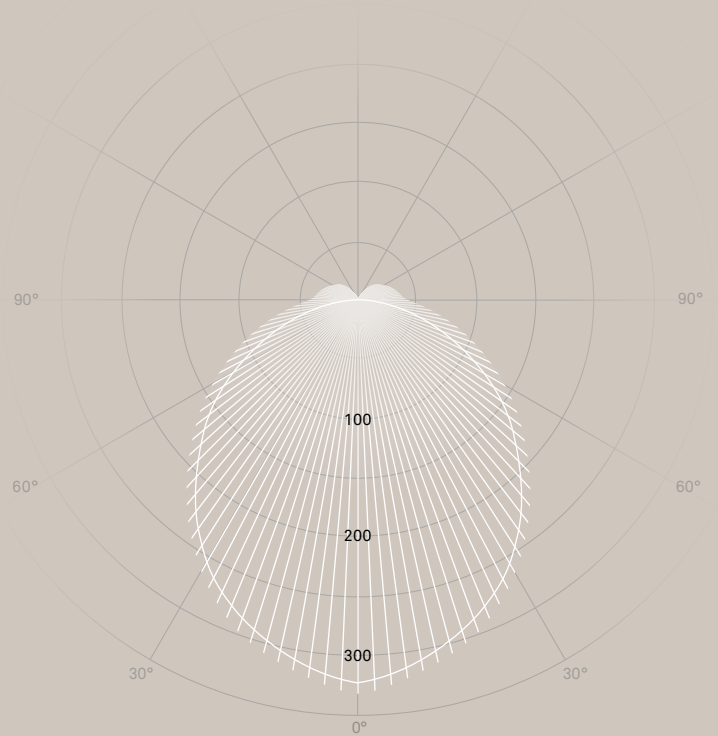

C90 / C270

C0 / C180

cd / 1000 lm



### Einzelleuchten

Single lamps

mit Diffusor opal,  
rundumstrahlend  
with diffuser opal,  
omnidirectional

Leuchtgehäuse Lamp housing	Alu-Strangpress Extruded aluminium
Farben Colours	farblos eloxiert / schwarz RAL 9005 / weiss RAL 9003 natural anodised / black RAL 9005 / white RAL 9003
Farbtemperaturen Colour temperatures	2700 / 3000 / 4000 K
Leuchtenlichtstrom Luminaire luminous flux	960–3200 lm
Anschlussleistung Connected load	11–34 W
Nutzlebensdauer LED Service life LED	50'000 h L90 B10 (Ta 25 °C)
Betriebsgerät Control gear	EVG 230 V / 50 Hz PS 230 V / 50 Hz
Lichtregelung Lighting control	PhasenDIM, DALI / TouchDIM Phase-cut, DALI / TouchDIM

Zur Montage an Decke,  
Wand oder als Pendelleuchte  
(Pflichtzubehör separat  
bestellen)

For mounting on the ceiling,  
wall or as pendant lamp  
(order essential accessories  
separately)

Kunstglas-Diffusor opal  
Acrylic glass diffuser opal

### Anbauleuchten

Optionales Zubehör:  
Montagebügel-Set  
Mounted lamps

Optional accessories:  
mounting bracketed set

### Pendelleuchten

Pflichtzubehör:

Pendel-Set

Optionales Zubehör:

Baldachin  
Pendant lamps

Essential accessories:

pendant set

Optional accessories:

canopy

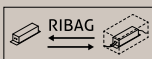
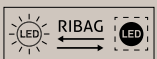

# IMPRESSUM IMPRINT



[ribag.com](http://ribag.com)



[@ribaglight](https://www.instagram.com/ribaglight)



[ribaglight](https://www.facebook.com/ribaglight)

## **Headquarters**

RIBAG Licht AG  
Kanalstrasse 18  
5745 Safenwil  
Switzerland  
Tel +41 62 737 90 10 (Sales)  
Tel +41 62 737 50 70 (Service)  
[info@ribag.com](mailto:info@ribag.com)  
[www.ribag.com](http://www.ribag.com)

© RIBAG Licht AG  
Lighting Collection 2024  
Subject to modifications



