

RIBAG

CUBO

Montageanleitung
Instructions de montage
Istruzioni per il montaggio
Fitting instructions

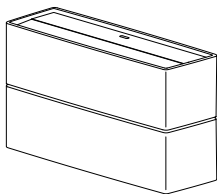

RIBAG Licht AG
Kanalstrasse 18, 5745 Safenwil, Switzerland
Service: Tel. +41 62 737 50 70, service@ribag.com

BT 1338.03/03.22

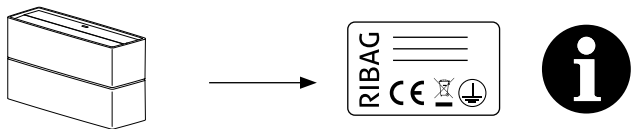
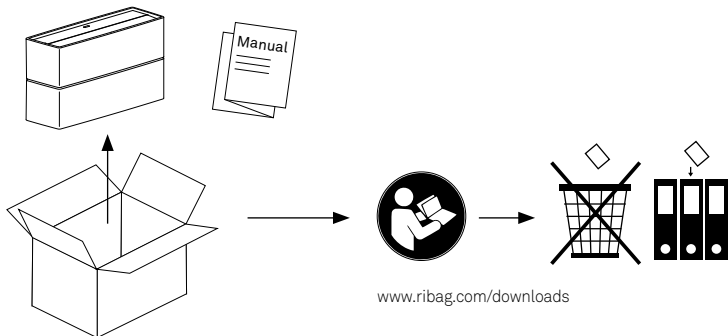

A collection of safety and technical information icons:

- Warning symbol (exclamation mark in a triangle).
- Screwdriver icon.
- Expert icon (person wearing a cap and a vest labeled "EXPERT").
- High voltage warning symbol (lightning bolt in a triangle).
- Grounding symbol (vertical line with three horizontal bars).
- Prohibition symbol (crossed-out house with a lightning bolt).
- Temperature symbol (t_a 25°C).
- Prohibition symbol (crossed-out trash bin).
- CE mark.
- House with arrow symbol (indicates indoor use).
- IP20 protection rating.
- Scale bar (indicates dimensions in mm).
- LED indicator symbol (sun with "LED" text).
- RIBAG logo with arrows pointing to a dashed box containing "LED".
- RIBAG logo with arrows pointing to a dashed box containing a diagram of the product.
- Energy efficiency class symbol (A ↑ G) with a large "E" in a grey arrow pointing right.

DE

Sie haben sich für ein zuverlässiges RIBAG-Markenprodukt entschieden. Bei fachgerechter Installation und sachgemässer Handhabung dürfen Sie sich lange Zeit daran freuen. Bitte beachten Sie die Montageanleitung und die örtlichen Installationsvorschriften.

Wichtig:

- Die Montage der Leuchten muss durch autorisiertes Personal erfolgen.
- Das Arbeiten an der Leuchte bei anliegender Spannung ist untersagt.
- enthält eingebaute LED-Lampen, Lampen durch den Hersteller austauschbar
- Maximale Leistungsstufe der Lichtquelle, gem. Angaben auf den Leuchten, beachten und unbedingt einhalten. Nichtbeachtung kann zur Zerstörung der Lichtquelle führen.
- Betriebsgeräte müssen für LED's geeignet sein und der Norm EN 61347-2-13 entsprechen.
- Für einen optimalen Betrieb der Leuchte ist eine regelmässige, vorsichtige Reinigung notwendig.

Für Artikel, die ohne unsere ausdrückliche Zustimmung verändert werden, entfällt jede Haftung.

Druckfehler und technische Änderungen vorbehalten.

FR

Vous avez fait votre choix en faveur d'un produit fiable de la marque RIBAG. Installé dans les règles de l'art et manipulé avec précaution, ce produit vous donnera entière satisfaction pendant très longtemps. Merci de suivre les consignes de montage et de respecter les prescriptions locales d'installation.

Important:

- Le montage des luminaires doit être effectué par personnel autorisé.
- Il est interdit de travailler sur le luminaire sous tension.
- contient des lampes LED intégrées, lampes remplaçables par le fabricant
- Tenir compte de la puissance maximale des luminaires indiquée et la respecter impérativement. Le non-respect de cette consigne peut entraîner la destruction des modules à LED.
- Les appareillages doivent convenir pour LED et être en conformité avec la norme EN 61347-2-13.
- Un nettoyage régulier effectué avec précaution est indispensable pour assurer un fonctionnement optimal du luminaire.

Nous n'assumons également aucune responsabilité pour les articles qui subissent des modifications sans notre approbation expresse.

Sous réserve d'erreurs d'impression et de modifications techniques.

IT

Avete deciso di acquistare un prodotto affidabile della marca RIBAG. Rimarrete soddisfatti per molto tempo dell'installazione eseguita a regola d'arte e della messa in funzione adeguata. Vi preghiamo di prestare particolare attenzione alle istruzioni per il montaggio e alle disposizioni locali adottate in materia di installazione.

Importante:

- Il montaggio delle lampade deve essere eseguito da personale specializzato.
- È vietato lavorare alle lampade sotto tensione.
- contiene lampade LED integrate, lampade sostituibili dal fabbricante
- Osservare e rispettare rigorosamente il livello di potenza delle lampade, come indicato sulle luci stesse. In caso contrario i moduli LED possono andare distrutti.
- Gli alimentatori devono essere adatti ai moduli LED e conformi alla normativa EN 61347-2-13.
- Per un funzionamento ottimale delle luci, è indispensabile una pulizia regolare e meticolosa.

Non ci assumiamo alcuna responsabilità per gli articoli modificati senza una nostra autorizzazione espressa.

Non si escludono errori di stampa e modifiche tecniche.

EN

You have purchased a reliable RIBAG brand product. Provided it is expertly installed and correctly operated you will enjoy its use for a very long time. Please observe the fitting instructions and the local installation regulations.

Important:

- The lamp must be fitted by qualified electrician personnel.
- Working on the lamp is prohibited if voltage is present / is only allowed under voltage-free conditions.
- contains built-in LED lamps, lamps replaceable by the manufacturer
- Please observe and maintain the maximum power stage of the lamps as stated on the lighting unit. Otherwise, the LED modules may be destroyed.
- Control gear must be suitable for LEDs and comply with the EN 61347-2-13 standard.
- For optimum operation the lighting units should be regularly and carefully cleaned.

All liability is declined for items which have been modified without our express agreement.

We reserve the right to make any technical changes and disclaim any responsibility for possible printing error.

DE Anbauleuchte mit Trafo **FR** Luminaire à monter avec transformateur
IT Lampada a soffitto con trasformatore **EN** Mounted lamp with transformer

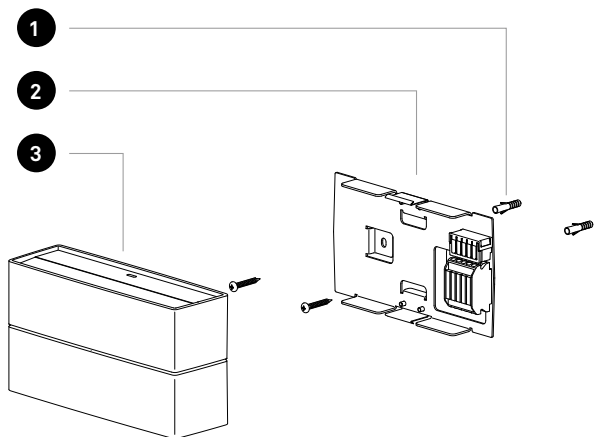

1

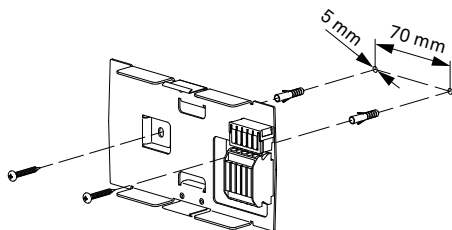

2

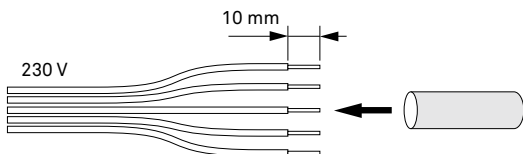
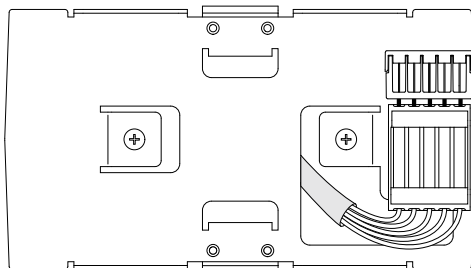

3

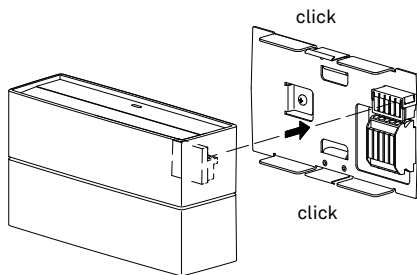

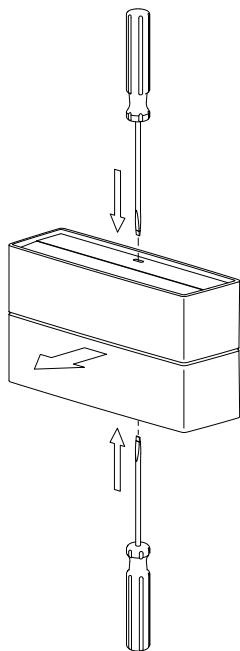
A**DE** Demontage **FR** Démontage **IT** Smontaggio **EN** Demounting

DE Anschlussschema für nicht dimmbare Leuchten

FR Schéma de branchement pour luminaires sans variateur

IT Schema di collegamento per lampade non dimmerabili

EN Connection scheme for non-dimmable lamps

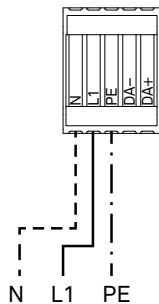

- DE** Anschlussschema für DALI-Betrieb
FR Schéma de branchement pour luminaires en mode DALI
IT Schema di collegamento per lampade in modalità DALI
EN Connection scheme for DALI operation

- DE** DALI-Anschlüsse polaritätsfrei
FR Branchements DALI sans polarité
IT Attacchi DALI indipendenti dalla polarità
EN DALI terminals with reserve polarity protection

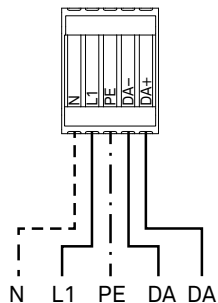

- DE** Anschlussschema für TouchDim-Betrieb
FR Schéma de branchement pour luminaires en mode TouchDim
IT Schema di collegamento per lampade in modalità TouchDim
EN Connection scheme for TouchDim operation

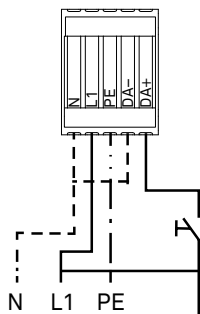

- DE** Anschlussschema für PhasenDim-Betrieb
FR Schéma de branchement pour luminaires en mode PhaseDim
IT Schema di collegamento per lampade in modalità dimmer a taglio di fase
EN Connection scheme for PhaseCut operation

- DE** Liste kompatibler LED Phasen-Dimmer:
FR Liste de compatibilité des dimmer de phase sur:
IT Lista di compatibilità degli dimmer a taglio di fase sotto:
EN Compatibilitylist of PhaseCut models under:
www.ribag.com/dim

