

**Planungshinweise:**

Sämtliches Zubehör separat bestellen

**Planning guide:**

Order all accessories separately

**KIVO 140**

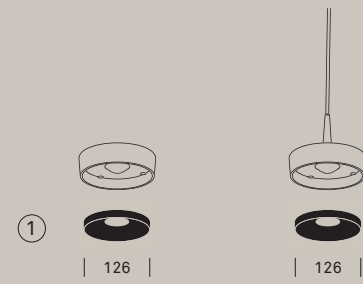

**Montagevarianten**

Mounting options

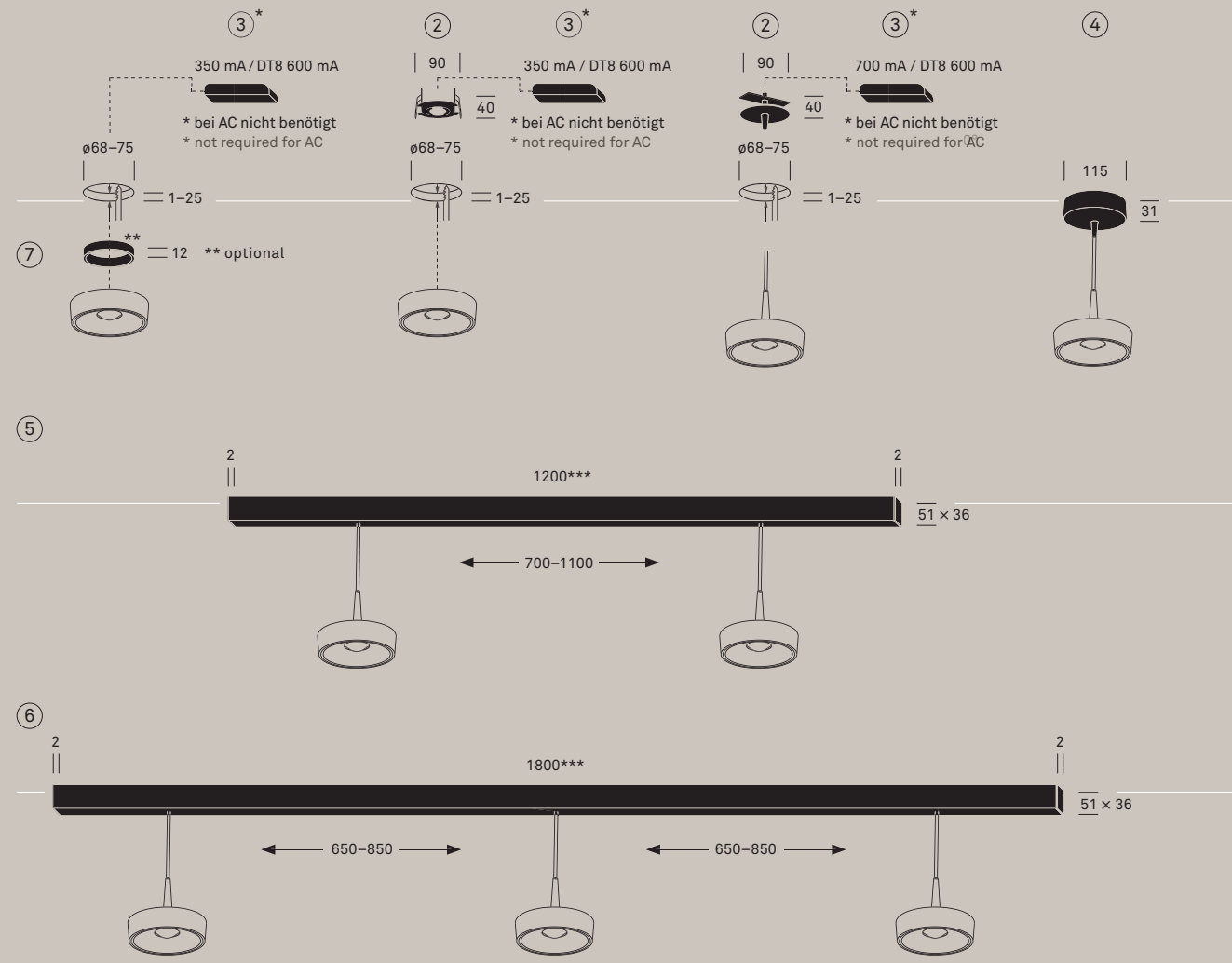

**KIVO 270**

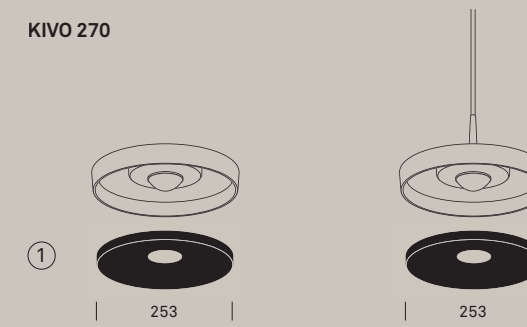

**Montagevarianten**

Mounting options

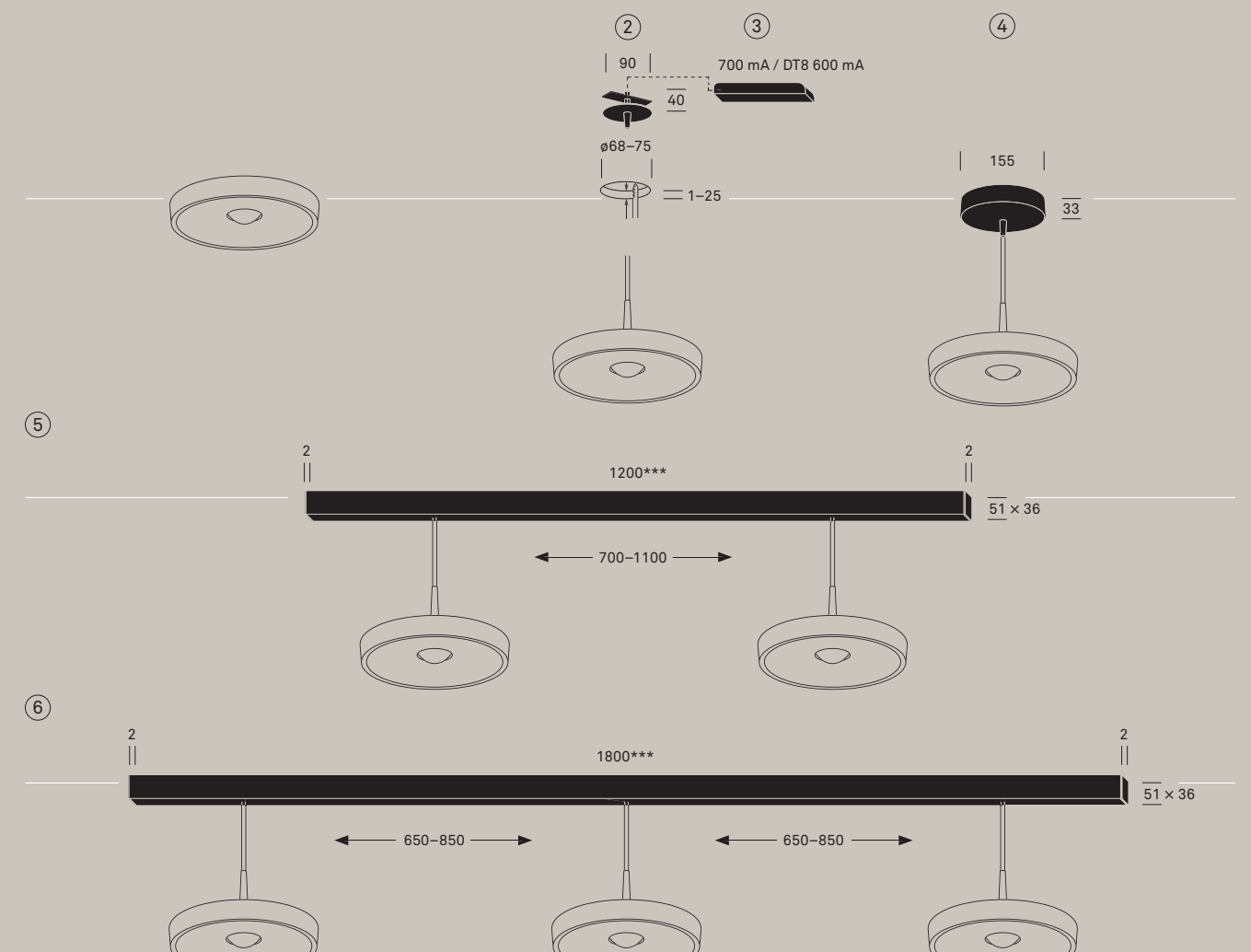

- 1 Wechselblende  
Interchangeable shade
- 2 Hohlraumadapter  
Cavity adapter
- 3 Betriebsgerät  
Control gear

- 4 Baldachin mit Betriebsgerät  
Canopy with control gear
- 5 Tragschiene 2 Pendelleuchten  
(kompatibel mit MILUM-Lichtsystem)  
Mounting rail for 2 pendant lamps (compatible with MILUM lighting system)

- 6 Tragschiene 3 Pendelleuchten  
(kompatibel mit MILUM-Lichtsystem)  
Mounting rail for 3 pendant lamps (compatible with MILUM lighting system)
- 7 Distanzring (optional)  
Distance ring (optional)

\*\*\* Länge ohne Endplatten  
Length without end plates

\*\*\* Länge ohne Endplatten  
Length without end plates



43

ø140

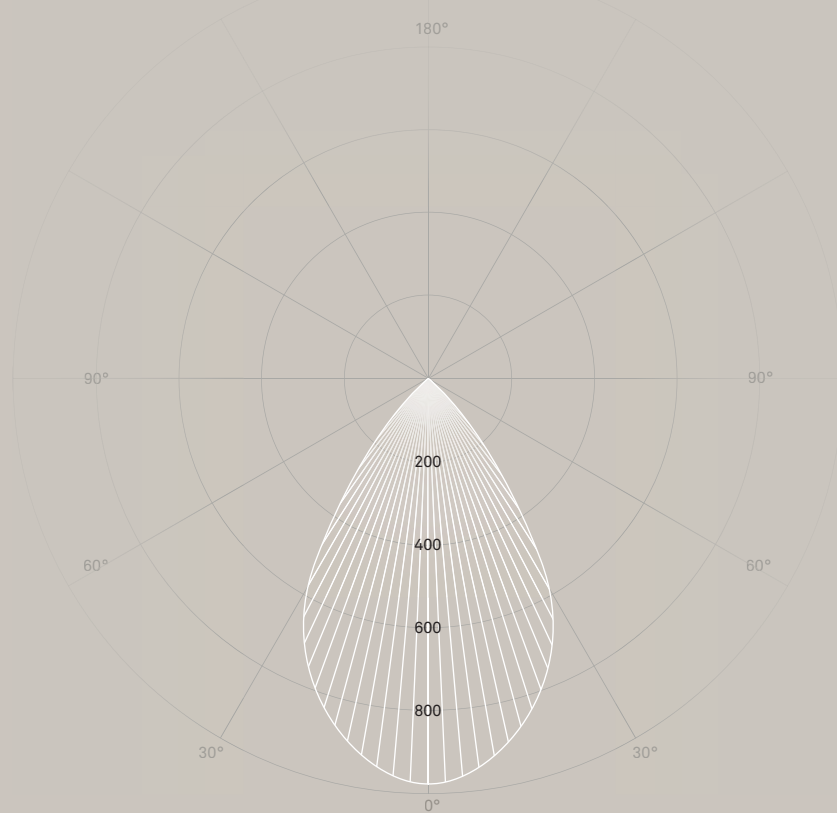

43

ø140

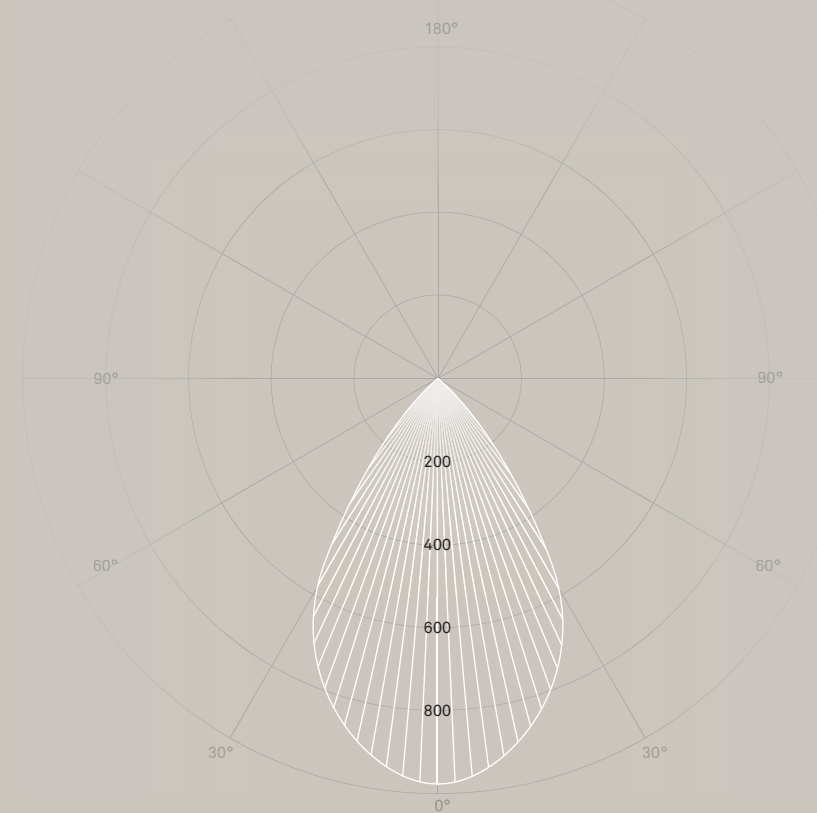

### Deckenleuchten Ceiling lamps

**ø140 mm  
mit externem Betriebsgerät  
with external control gear**

Leuchtengehäuse Lamp housing	Alu-Druckguss Diecast aluminium
Farben Colours	schwarz RAL 9005 / grau RAL 9006 / weiss RAL 9003, Wechselblenden in verschiedenen Farben, separat bestellen black RAL 9005 / grey RAL 9006 / white RAL 9003, Interchangeable shades in different colours, order separately
Farbtemperaturen Colour temperatures	2700 / 3000 / 4000 / 2200–5000 K
Leuchtenlichtstrom Luminaire luminous flux	630–1350 lm
Anschlussleistung Connected load	11–12 W
Nutzlebensdauer LED Service life LED	50'000 h L90 B10 (Ta 25 °C)
Betriebsgerät Control gear	EVG 230 V / 50 Hz, Konstantstrom 350 mA / DT8 600 mA (Betriebsgerät separat bestellen) PS 230 V / 50 Hz, constant current 350 mA / DT8 600 mA (order control gear separately)
Lichtregelung Lighting control	Ein / Aus, PhasenDIM, DALI / TouchDIM, DALI DT8 On / Off, phase-cut, DALI / TouchDIM, DALI DT8

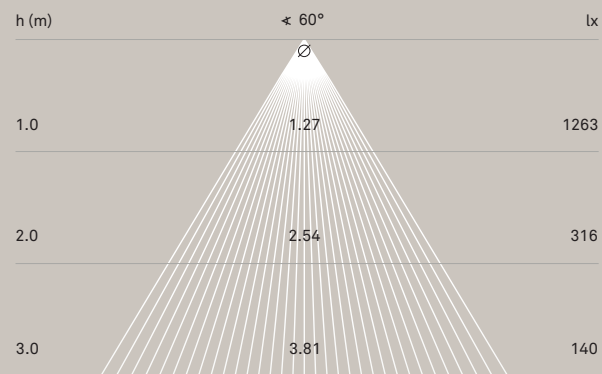

Zur Montage an Decke  
(Pflichtzubehör separat  
bestellen)  
For mounting on the ceiling  
(order essential accessories  
separately)

Hochwertige Glaslinsen-Technologie mit Ausstrahlwinkel 60°  
High-quality glass lens technology with a beam angle of 60°

Pflichtzubehör:  
Wechselblenden, externe  
Betriebsgeräte, Seite 223  
Essential accessories:  
Interchangeable shades,  
external control gears,  
page 223

Optionales Zubehör:  
Hohlraumadapter, Distanzring,  
Seite 225  
Optional accessories:  
Cavity adapter, distance ring,  
page 225

### Deckenleuchten Ceiling lamps

**ø140 mm AC (230 V)**

Leuchtengehäuse Lamp housing	Alu-Druckguss Diecast aluminium
Farben Colours	schwarz RAL 9005 / grau RAL 9006 / weiss RAL 9003, Wechselblenden in verschiedenen Farben, separat bestellen black RAL 9005 / grey RAL 9006 / white RAL 9003, Interchangeable shades in different colours, order separately
Farbtemperaturen Colour temperatures	2700 / 3000 / 4000 K (auf Anfrage) 2700 / 3000 / 4000 K (on request)
Leuchtenlichtstrom Luminaire luminous flux	920 lm
Anschlussleistung Connected load	12 W
Nutzlebensdauer LED Service life LED	50'000 h L90 B10 (Ta 25 °C)

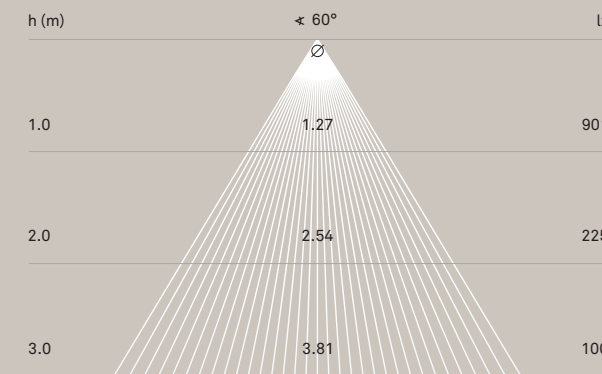

Zur Montage an Decke und Anschluss an 230 V AC / 50 Hz Netzspannung, dimmbar via LED-Phasendimmer  
(Liste kompatibler Dimmer: ribag.com/downloads)  
For mounting on the ceiling and connection to 230 V AC / 50 Hz mains voltage, dimmable with LED-phase-cut dimmer (List of compatible dimmers: ribag.com/downloads)

Hochwertige Glaslinsen-Technologie mit Ausstrahlwinkel 60°  
High-quality glass lens technology with a beam angle of 60°

Pflichtzubehör:  
Wechselblenden, Seite 223  
Essential accessories:  
Interchangeable shades,  
page 223

Optionales Zubehör:  
Hohlraumadapter, Distanzring,  
Seite 225  
Optional accessories:  
Cavity adapter, distance ring,  
page 225

